

# Mamiya Leaf

## User Guide

Credo Digital Backs

Mamiya 645DF+/645DF Camera



## **On Rights**

©2012-2014 Leaf Imaging Ltd. All rights reserved.

Colorspace images created in CROMIX ColorThink.

## **On Liability**

The information in this User Guide is provided "as is".

Under no circumstances, including negligence, shall Leaf Imaging Ltd. be liable for any incidental, special, direct, indirect or consequential damages arising out of or relating to use of the information provided in this guide with or without the software and/or hardware described in the guide.

## **Trademarks and Acknowledgements**

Mamiya and Mamiya Sekor are registered trademarks.

Capture One and Phase One are either registered trademarks or trademarks of Phase One A/S in the European Union and/or other countries.

All other trademarks are the property of their respective owners.

This product includes DNG technology under license by Adobe Systems Incorporated.

# Contents

<b>1.0 Introduction</b>	<b>7</b>	3.5 Focus Modes	28
1.1 Warranty	8	3.7 Using Focus Lock and Infrared Focusing	31
1.2 Installation and Activation of Software	8	3.8 Drive Dial	32
1.3 Activation	9	3.9 Exposure Modes	33
1.4 Screen Calibration	10	3.10 Flash Photography	38
<b>2.0 The 645DF+ Camera and Credo Digital Back System</b>	<b>11</b>	3.11 Flash Compensation Settings	41
2.1 Charging the Batteries for the Credo Digital Back	11	<b>4.0 Introduction to the Credo Series Digital Back</b>	<b>44</b>
2.2 Batteries for Camera	12	4.1 Quick Start (shooting untethered)	45
2.3 Sleep Mode	13	4.2 General Hardware Setup	46
2.4 Attach and Remove a Lens	14	4.3 Indicator Light	47
2.5 Adjusting the Strap	15	4.4 CF Card LED	47
2.6 Attaching the Leaf Credo back	16	4.5 Tethered and Untethered Operations	48
2.7 Parts of the Camera System	17	4.6 CompactFlash Card Usage	50
2.8 The Displays	18	4.7 Secure Storage System (3S)	51
2.9 Camera Display Abbreviations	19	4.8 Formatting your Memory Card	52
2.10 The Buttons on the Back	20	<b>5.0 Navigating the Credo User Interface and Menu System</b>	<b>53</b>
2.11 LED Lights	20	5.1 Soft Buttons	54
2.12 Setting Date and Time	21	5.2 Touchscreen Operation	55
2.13 Setting Diopter	21	5.3 ISO	56
2.14 Eyepiece Shutter	22	5.4 White Balance	57
<b>3.0 Basic Functions</b>	<b>24</b>	5.5 Custom White Balance	58
3.1 Setting ISO	24	<b>6.0 Browse Mode</b>	<b>59</b>
3.2 Setting White Balance	24	6.1 Browse Mode Views	60
3.3 Setting the Shutter Release, Focus, Exposure and Metering modes	25	6.2 Dynamic Menu	61
3.4 Measuring Light – Exposure Metering	27	6.3 Info Bar	62

6.4	Browse Mode Navigation.....	62	7.1.21	Flash Sync.....	77
6.5	Zoom.....	62	7.1.22	Beep.....	77
6.6	Rating Images.....	63	7.1.23	Shutter in Tv/Av/P.....	77
6.7	Previewing Images in B&W.....	63	7.1.24	Shutter in M/X.....	78
6.8	Deleting Images.....	64	7.1.25	AF priority.....	78
6.9	Deleting in Browse View.....	65	7.1.26	Active Custom Set.....	79
6.10	Grid.....	66	7.1.27	Restore to Default.....	79
6.11	Tools.....	68	7.1.28	About System.....	79
<b>7.0</b>	<b>Settings Menu</b>	<b>71</b>	7.2	Power Management.....	80
7.1	Camera Settings (Custom Functionality).....	72	7.3	Format Card.....	81
7.1.1	Setup C1, C2 or C3.....	72	7.4	Check Disk.....	81
7.1.2	Exposure Program.....	72	7.5	Storage Mode.....	81
7.1.3	AF Area.....	72	7.6	File Format.....	82
7.1.4	Light Metering.....	72	7.7	Camera Mode.....	82
7.1.5	Custom Function Set.....	73	7.8	Shutter Latency.....	82
7.1.6	Setup Custom A, B or C.....	73	7.9	Image Orientation.....	82
7.1.7	EV Step.....	73	7.10	Auto Preview Mode.....	83
7.1.8	Lens Change.....	73	7.11	Display.....	83
7.1.9	Sleep Timer.....	73	7.12	Ready Beep.....	84
7.1.10	Battery Type.....	74	7.13	Date and Time.....	84
7.1.11	Bracketing.....	74	7.14	Language.....	84
7.1.12	Front/Rear Dial.....	74	7.15	Restore to Default.....	85
7.1.13	Rear Dial in P mode.....	74	7.16	Firmware.....	85
7.1.14	Dial Direction.....	74	7.17	About.....	86
7.1.15	AEL/AFL button.....	75	<b>9.0</b>	<b>Advanced 645DF+ Camera Functions</b>	<b>88</b>
7.1.16	Release Button.....	75	9.1	Exposure Compensation.....	88
7.1.17	AEL.....	75	9.2	AE Lock.....	89
7.1.18	AFL.....	76	9.3	Metered-Value Difference Indicator.....	90
7.1.19	M-Mode AEL.....	76	9.4	Auto Bracketing.....	91
7.1.20	AF Assist Light.....	76	9.5	Taking Photos with the Mirror Up.....	93



9.6	Mirror Up Delay.....	94	13.1	More Details: Leaf Credo and Mamiya 645 Series Cameras .....	118
9.7	Bulb Mode and Long Exposure.....	95	<b>14.0</b>	<b>Leaf Credo back for Mamiya RZ67 PRO IID</b>	<b>119</b>
9.8	Camera Display Light.....	95	14.1	Mounting Leaf Credo back on the Mamiya RZ67 PRO IID.....	119
9.9	Front/Rear Dial Lock Mechanisms.....	96	14.2	Viewfinder Masking.....	119
9.10	Self-Timer Mode.....	97	14.3	More Details: Mamiya RZ67 Pro IID.....	121
9.11	Interval Photography.....	98	<b>15.0</b>	<b>Leaf Credo back for Hasselblad V Series</b>	<b>122</b>
9.12	Depth of Field .....	99	15.1	Mounting the Leaf Credo back on a Hasselblad V Series Camera.....	122
9.13	Infrared Photography.....	100	15.2	Mounting a Viewfinder Mask on a Hasselblad V Series Camera.....	123
9.14	Custom Function.....	101	15.3	More Details: Hasselblad V Series.....	124
9.15	Types of Custom Functions.....	102	15.4	Hasselblad 555 ELD.....	125
9.16	Custom Dial Modes C1, C2 or C3.....	106	15.5	Hasselblad 553 ELX.....	126
9.17	Lenses and Multi-Mount.....	107	15.6	Hasselblad 501 CM and 503 CW without Winder.....	127
9.18	Function of the Phase One Lens Adapter.....	107	15.7	Hasselblad 503 CW with Winder CW.....	127
<b>10.0</b>	<b>Maintenance</b>	<b>108</b>	15.8	Cables shipped with Leaf Credo back for Hasselblad V .....	128
10.1	Changing the Focusing Screen.....	108	<b>16.0</b>	<b>Leaf Credo Back for Hasselblad H Series</b>	<b>129</b>
10.2	Battery Socket.....	109	16.1	Mounting the Leaf Credo back on the Hasselblad H1/H2.....	130
10.3	Tripod/Electronic Shutter Release Contact.....	109	16.2	Viewfinder Masking.....	130
10.4	Camera Display Error-Notification.....	110	16.3	More Details: Hasselblad H Series.....	131
10.5	Lens Maintenance.....	111	16.4	Cables Shipped with Leaf Credo back for Hasselblad H.....	133
10.6	Back Maintenance.....	111	<b>17.0</b>	<b>Leaf Credo back for Contax 645</b>	<b>134</b>
10.7	IR Filter on the CCD.....	111	17.1	Mounting Leaf Credo back on a Contax 645.....	134
10.8	Mamiya 645DF+ Camera Body Specifications.....	112	17.2	Viewfinder Masking.....	135
10.9	Mamiya 645DF+ Housing Specification.....	113	17.3	More Details: Contax 645.....	136
<b>11.0</b>	<b>Software</b>	<b>114</b>	17.4	Flash Lead Connection.....	137
11.1	Importing Images.....	114	17.5	Cables Shipped with Leaf Credo back for the Contax 645 (Gold package only).....	138
<b>12.0</b>	<b>End User Support Policy</b>	<b>115</b>			
12.1	Web Resources.....	116			
<b>13.0</b>	<b>Open Platform – Freedom of Choice</b>	<b>117</b>			

<b>18.0 Leaf Credo Back on View Cameras</b>	<b>139</b>
18.1 Using the 2-shot Release.....	140
18.2 Using the 1-shot Release.....	140
18.3 Shutter Latency Settings for Technical Camera Adapters.....	141
<b>19.0 Live View</b>	<b>142</b>
19.1 Starting Live View.....	143
19.2 White Balance.....	144
19.3 Quality and Brightness.....	144
19.4 Zoom.....	145
19.5 Grid.....	145
19.6 Auto Stop and Start.....	145
19.7 Accessories.....	146
19.8 Live View Camera Support.....	147
<b>20.0 Appendix</b>	<b>149</b>

# 1.0 Introduction

Thank you for choosing a Mamiya Leaf product.

The Mamiya 645DF+ and Leaf Credo digital back is the most powerful digital camera solution whether you are working on location or tethered in a studio.

The Leaf Credo 80, 60 and 40 digital camera backs feature maximum resolutions of 80, 60.5 and 40 high-quality megapixels respectively. This series sets new standards for medium format camera system handling and performance.

The Leaf Credo series system gives you the absolute best solution when it comes to image quality and workflow. Capture One has been optimized for shooting with Leaf Credo digital backs, and is available for both Mac OS X and Windows operating systems.

Together with the Leaf Credo series backs, this professional RAW converter and image editing software delivers the world's highest image quality with excellent color and detail. The software comprises all the tools required to capture, organize, edit, share and print images for an efficient workflow.

The Mamiya 645DF+ camera delivers incredible versatility with support for what is arguably the widest array of focal plane and leaf shutter lenses on the market. Mamiya Leaf is committed to providing the best digital solution for the professional photographer and also ensuring the photographer's freedom of choice regarding lenses, bodies, back, software and accessories.

At Mamiya Leaf we are committed to providing you the best solution for professional photography. This User Guide covers the Mamiya 645DF+ and Leaf Credo series features and functionality. Although this user guide is written for the Mamiya 645DF+, many of the procedures apply to the Mamiya 645DF as well.

We sincerely hope you enjoy working with this innovative camera platform.



## 1.1 Warranty

Please read the warranty certificate found in the Quick Guide. Should any problem occur, contact your local dealer (place of purchase) to facilitate a repair. Do not try to repair the camera yourself. An unauthorized attempt to repair the camera terminates the warranty.

## 1.2 Installation and Activation of Software

An Internet connection is needed to activate Capture One.

### **Install on Mac:**

Capture One software includes an easy-to-use installer that installs all the software necessary to run the application on Mac OS X 10.5.8 or later.

To install the software, follow the procedure below:

1. Either install from the CD (included with purchase) or download the application from the Mamiya Leaf website: <http://www.mamiyaleaf.com>.
2. Open the Capture One disk image.
3. Read and accept the license agreement presented.
4. Drag the Capture One icon to the Applications folder.
5. Open Capture One from your Applications folder.

### **Install on Windows:**

Capture One includes an easy-to-use installer that installs all the software you need to run the application on a Windows based computer.

To install the software follow the procedure below:

6. Either install from the CD (included with purchase) or download the application from the Mamiya Leaf website: <http://www.mamiyaleaf.com>.
7. Run the executable software install file.
8. Read and accept the license agreement presented.
9. Follow the on-screen instructions to complete the installation.

**Note:** Capture One initiates installation of Microsoft® .NET Framework 3.0 if you don't already have it installed on your computer.

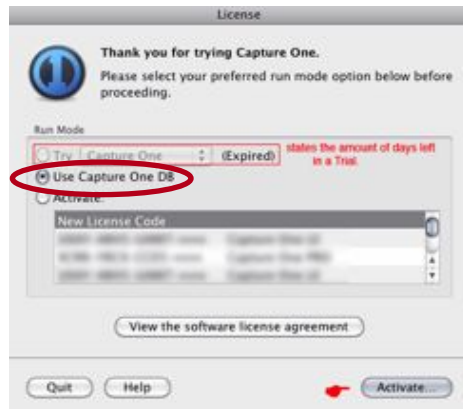

### 1.3 Activation

An Internet connection is needed to activate and update Capture One. Upon launching of Capture One, an Activation dialog box appears. (On a Windows-based PC the dialog box looks slightly different but the steps are the same).

1. Select **Use Capture One DB** to activate the Digital Back version of Capture One.
2. Click **Activate** to complete activation. A confirmation screen appears informing you of a successful activation.

If you have purchased a license for the Capture One Pro version:

1. Select **Activate > New License Code** to activate the Pro version of Capture One.
2. Click **Activate...** The License dialog box appears.
3. Fill in your 16 character Product Key and profile information and then click **Activate...** A confirmation screen appears informing you of a successful activation.

### Troubleshooting

If you are experiencing problems activating the software, follow the instructions provided in the application, read the software manual enclosed or visit the website for inspiration and troubleshooting:

[www.phaseone.com/support](http://www.phaseone.com/support)

### Deactivation of Capture One

An Internet connection is needed to deactivate Capture One.

1. Open the license dialogue box via the menu **Capture One > License**.
2. Click the **Deactivate** button.
3. Capture One returns to trial mode once it is deactivated. If the trial period for the computer expires, all current and pending processing is cancelled, and you are not able to continue working with the application until you reactivate it.
4. Confirm that you want to perform the deactivation. After doing so, you can activate Capture One on another computer.

## 1.4 Screen Calibration

Having a properly calibrated monitor is a critical factor when viewing images. Ensure that the digital viewing conditions are as accurate as possible. A quality monitor and calibration tool should help guarantee that displayed images on a screen are precisely rendered. Once a monitor has been calibrated; the color and brightness controls should be locked to prevent inadvertent changes.

Hardware-based monitor calibrators are now available at reasonable prices. The process is simple, quick and enables images to be viewed with confidence. Many higher level monitors have internal calibration software that works with professional calibration devices for ultimate accuracy.





## 2.0 The 645DF+ Camera and Credo Digital Back System

The Mamiya Leaf Camera system is created to provide as much flexibility and openness as possible. Follow the instructions below to setup and use your Mamiya Leaf camera system.

### 2.1 Charging the Batteries for the Credo Digital Back

Charge the batteries as soon you unpack the camera system.

Although only one battery can be used in the Leaf Credo back at a time, it is recommended to charge both batteries fully before you start.

Always keep a battery in the Leaf Credo back even when shooting tethered to a computer via a FireWire or USB connection. Go to page 80 for more details about charging the battery while tethered to a computer.

The battery charger can adapt to voltages within a range of 110 to 250 volts. It comes with an international set of power adapters. Select the appropriate one that fits your outlet and slide it in from the top to mount it in place securely.

Connect the unit to the outlet and charge the batteries (approximately 2.5 to 3 hours).

#### Purchasing Extra Batteries

The Leaf Credo back comes with two batteries (3400 mAh). You can purchase additional batteries or use Canon BP 915 batteries.

Some third party batteries may not fit into the digital back's battery compartment due to differences in the tolerances. Do not try to force a battery into the compartment. When pressing the battery release button it should slide in without being hindered.

#### Warning!

- Only use the charger to charge the specified batteries.
- Do not allow charger to get wet or exposed to moisture.
- Keep the charger out of reach of children.
- Once charging is completed, unplug the charger from power source.
- Only use the original mains adapter, 12V DC or car lead.
- Never apply excessive force when connecting or disconnecting a battery or contact plate.
- Keep all contacts clean.
- Do not force down any of the contacts.
- Do not short-circuit the contacts.
- Never store the battery connected to the charger for an extended period of time.
- Do not expose to excessive heat or naked flame.
- Do not dismantle or carry out any alteration to the product.
- Do not attempt to eat or swallow the battery.

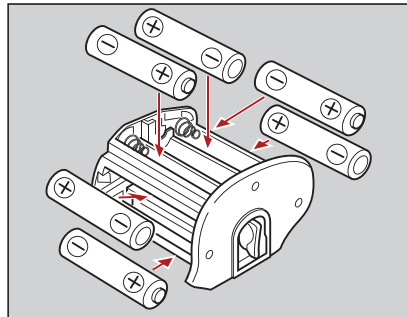
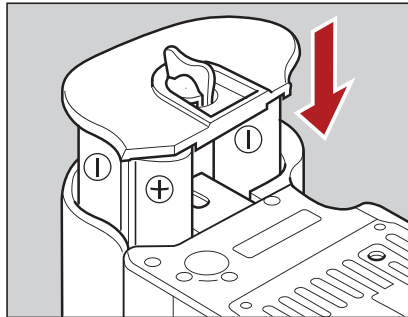
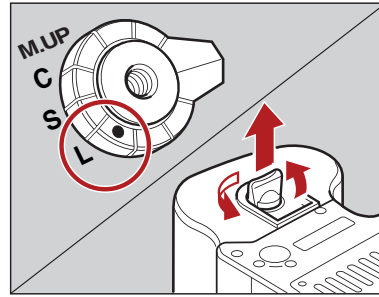

The batteries are sufficiently charged.



There is little power remaining. Have new batteries on hand. Camera still operates.



There is very little power remaining. Camera does not operate. Set the shutter release mode selector lever to **L** (to turn the power off) and replace the batteries with new ones.



When the batteries are emptied for power, **batt** flashes on the main LCD and the viewfinder's LCD when the shutter release button is pressed.

## 2.2 Batteries for Camera

Set the shutter release mode selector lever to **L** (to turn the power off).

Use the Mamiya Li-Ion rechargeable battery pack, six AA alkaline or rechargeable AA batteries. (If you are not using your Leaf Credo on a Mamiya 645DF+, skip to page 24.)

Li-Ion, NiCd or NiMH batteries should only be used in the camera body if CF04 is set to the specific type of rechargeable battery used. If using the Li-Ion battery pack, ensure that the custom function has been set to 2 (Li-Ion rechargeable battery).

### Inserting Li-Ion Battery Pack

1. Turn the battery pack lock lever counter clockwise.
2. Slide the Li-Ion battery pack into the camera's battery compartment.
3. Lock the battery by turning the lever clockwise. Make sure it is firmly attached.

### Inserting AA Batteries

1. Lift the battery case lock lever, turn it counter clockwise and pull out the battery holder.
2. Insert fresh batteries with the + and – ends as shown in the illustration.
3. Return the battery holder to its case and lock it by turning the lever clockwise. Make sure it is firmly attached.

**Note:** Ensure that the batteries are placed with the correct polarity.

### Checking the Battery Power

Set the Drive dial lever to **S** to turn the power on.

Check the battery condition in the lower left corner of the top LCD screen.

Always use six new batteries of the same type when replacing batteries. Do not mix different types of batteries or use old batteries with new ones. The camera can't function without a power source.

Never throw batteries in the garbage. When a battery does not work, ensure the battery is disposed of in an appropriate manner.



For the purpose of the descriptions and explanations provided in these instructions, it is assumed that the camera's power is on.

## 2.3 Sleep Mode

The camera's power is switched on when the shutter release mode selector is set to S, C or M.UP. In order to prevent the camera's batteries from discharging, sleep mode is automatically entered if no operations are performed for a specific period of time while the power is ON (with exposure metering status maintained).

In sleep mode, operating the shutter button or a function setting button restores power ON status.

In sleep mode, the external LCD screens are not active, only the marks shown in the figure are displayed. (These marks appear in program AE mode.)

1. Battery life of the originally supplied batteries is dependent on storage conditions.
2. Blots and fingerprints on the battery terminals may cause a loose connection and corrosion. Wipe them off before loading the batteries.
3. It is advised to carry spare batteries in remote or foreign locations.
4. Battery performance decreases in low temperatures. Keep them warm when in cold climates or locations. An external battery case (PE401) is available as an optional accessory.
5. Store the batteries in a cool and dry place, away from direct sunlight.
6. Remove the batteries from the camera body if you plan on not using the camera for a long time.
7. Replace the batteries with new ones as soon as they are exhausted. Liquid leakage from the battery can damage the camera.
8. Read the warnings on the batteries for their handling.

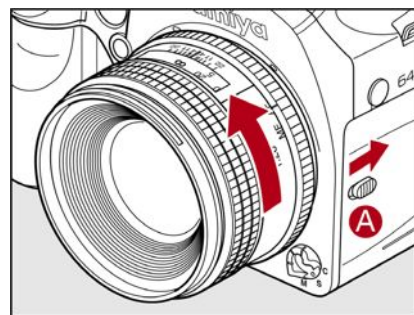
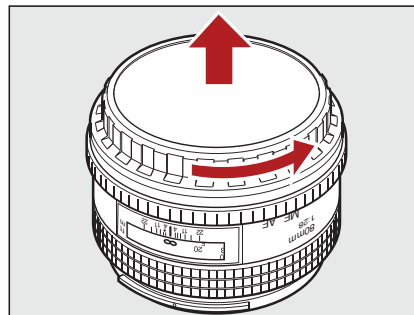
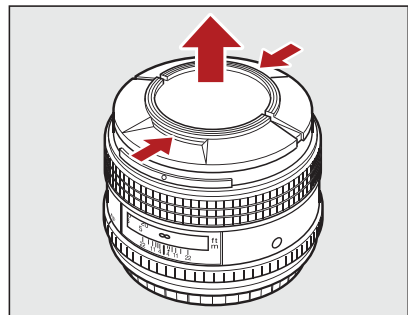
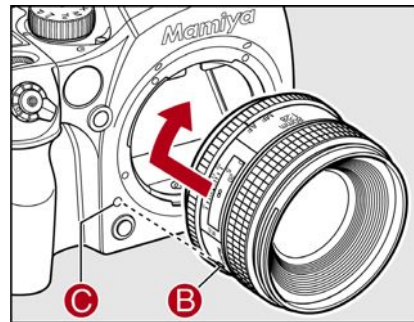
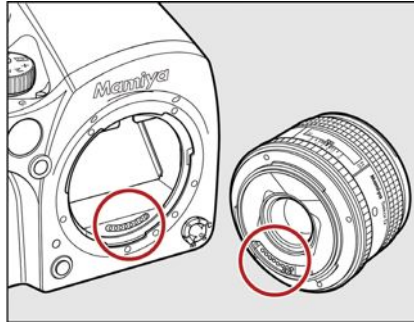
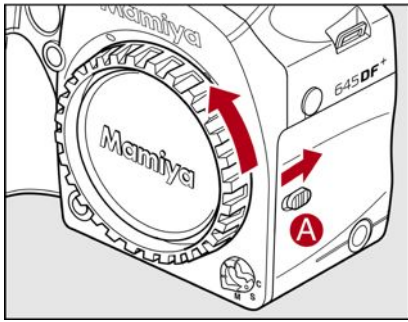

## 2.4 Attach and Remove a Lens

1. Remove the front body cap in the same way that you would remove a lens; push the lens release button **A** backward and then turn the front body cap or the lens itself counter clockwise and lift out.
2. Align the white alignment dot of the lens **B** (on the shiny flange) with the camera's white dot **C**. Mount the lens and rotate it clockwise until it clicks into place.
3. To remove the front lens cap, squeeze the shiny sections together and lift out (see image far left). To remove rear lens cap turn it counterclockwise.

### Remove a Lens

Slide the lens release button **A** back, rotate the lens counter clockwise until it stops, and lift it off. After removing the lens from the camera body, protect both ends by attaching the caps.

**Note:** Oil, dust, fingerprints or water on the electronic contacts could result in malfunction or corrosion. Wipe such impurities off with a clean piece of cloth. Do not tap the distance ring or other rotating parts when attaching the lens. When installing a lens, do not press the lens release button.

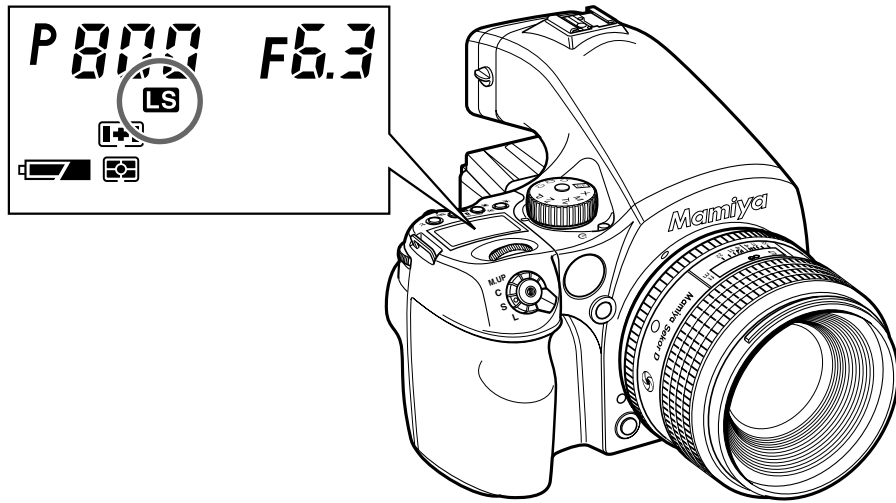

### Attach a Leaf Shutter Lens

Leaf shutter lenses are equipped with an internal shutter. Leaf shutter lenses are capable of high shutter speeds 1/800 sec or 1/1600 on Leaf Credo series backs with flash synchronization, which is particularly useful for fill-in flash photography in bright ambient shooting conditions.

When a leaf shutter lens is attached and the leaf shutter is used, the letters LS appear in the main LCD screen.

### 2.5 Adjusting the Strap

Put the neck strap through the mounts and secure it to the buckle as illustrated. After attaching the strap, pull it and ensure it does not loosen at the buckle.

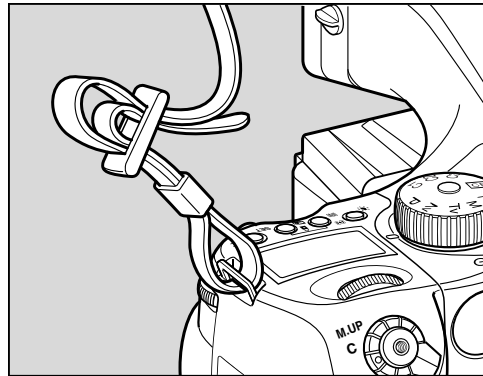



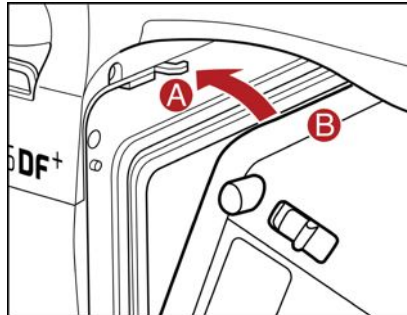
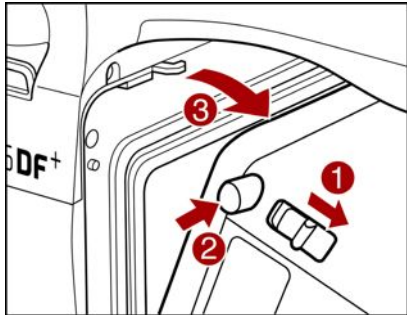
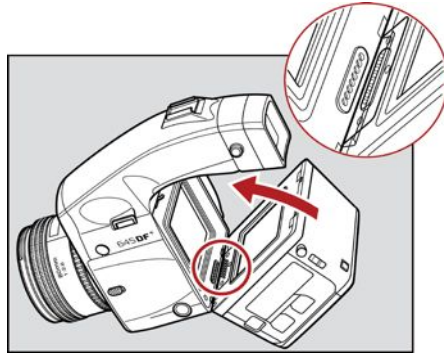
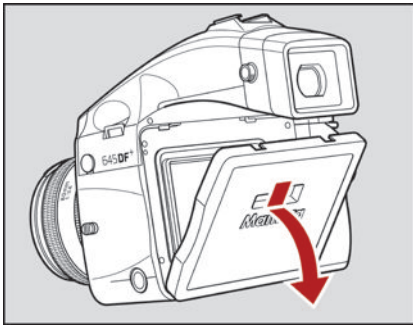

## 2.6 Attaching the Leaf Credo Back

The Leaf Credo back is fully integrated with the camera body and functions as a part of the whole camera system.

Ensure that the Mamiya 645DF+ camera mirror is up and the shutter is open when there isn't a digital back attached.

When attaching the Leaf Credo back to the camera body the shutter closes and the mirror comes down.

First remove the cover. Next, ensure that the bottom part of the Leaf Credo back is placed correctly in the lower locking mechanism on the back of the camera body before the upper locking mechanism **A+B** is pressed together. Failure to do this can cause an error with the camera body where the shutter continuously opens and closes. If this occurs, remove the Leaf Credo back. Make sure the camera body is powered, press the digital back release button **2** while mounting the digital back, lock the mounted back by sliding the digital back lock **1** toward the camera.

Be aware that the shutter should be in the correct starting position (shutter open). If this is not the case, attach and remove the Leaf Credo back again to make sure that the camera body gets in the correct starting position.

Remove the Leaf Credo back by sliding the digital back lock **1**, pushing in the digital back release button **2**, and by gently pulling away the top of the back first. Be careful with the contacts and protective glass on the back. Your Leaf Credo back should always be protected by its plate when it is not attached to the camera.



## 2.7 Parts of the Camera System

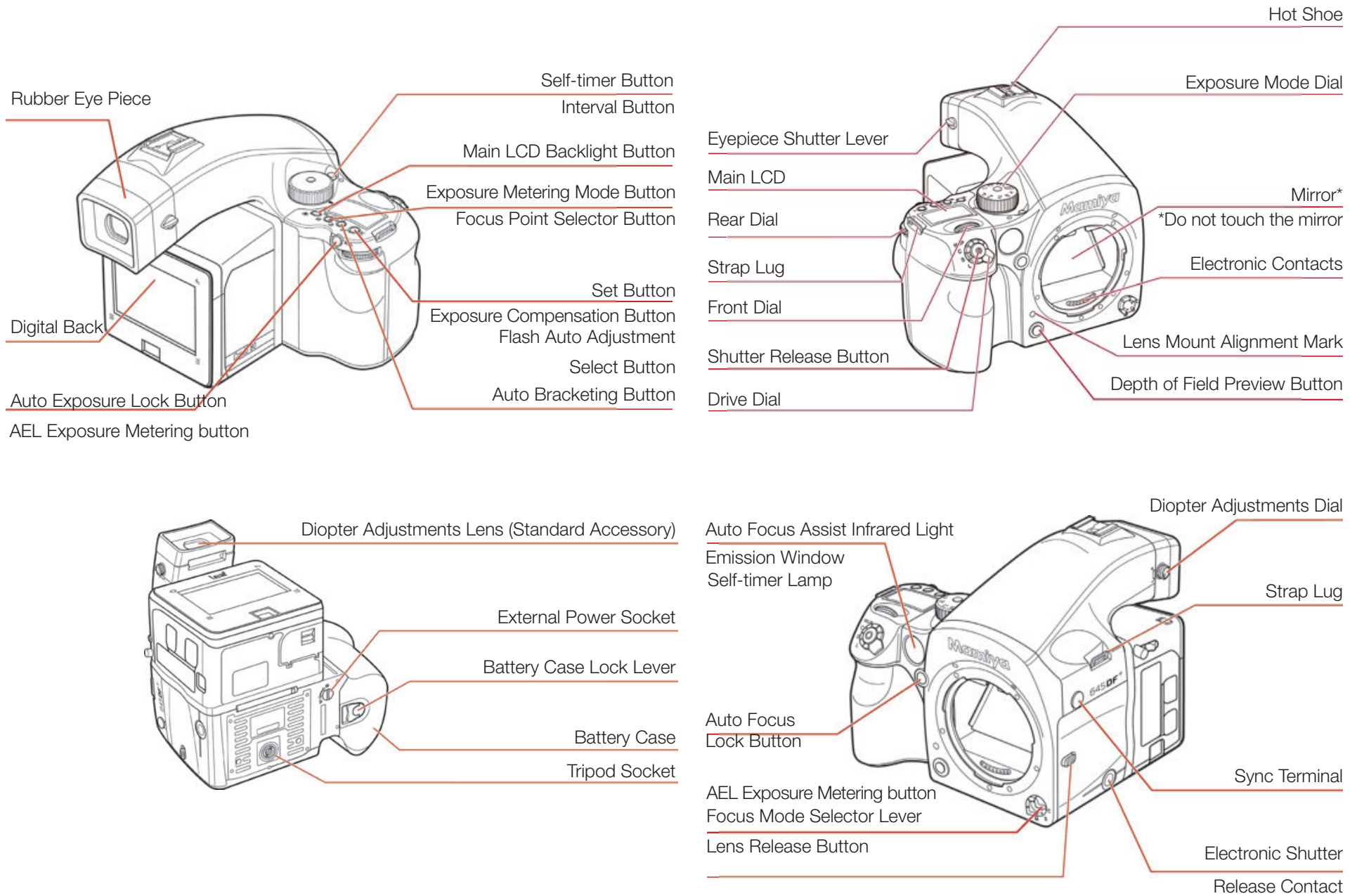

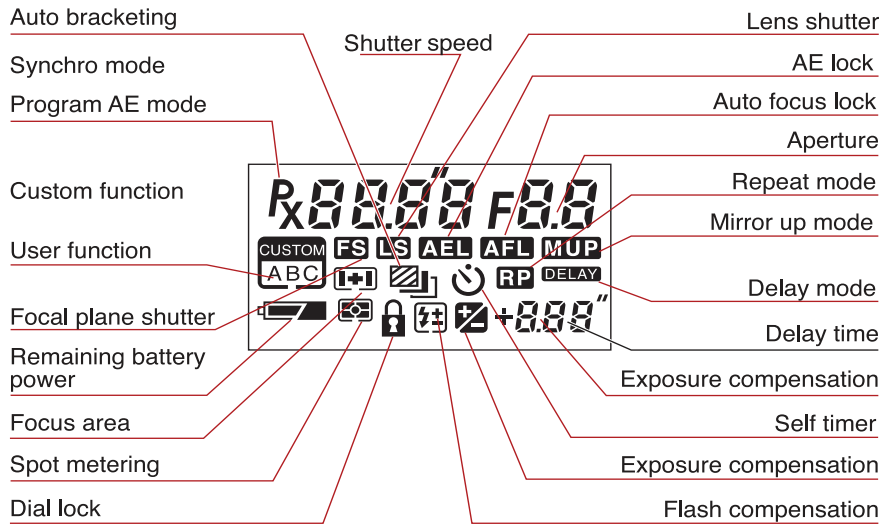

During actual use, only the relevant icons and indicators are displayed.

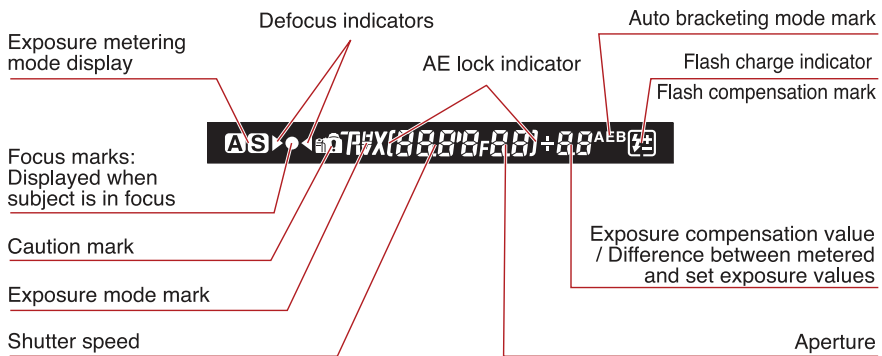

During actual use, only the relevant icons and indicators are displayed.

## 2.8 The Displays

### Liquid Crystal Display

The liquid crystal display (LCD) display on the camera body provides you with a lot of valuable information. This includes many features and settings including, but not limited to shutter speed, aperture value, exposure program, exposure compensations and metering modes. Viewfinder Display

The most relevant information regarding the exposure and camera settings can be seen on the bottom display in the viewfinder along with the autofocus mark that indicates correct focus.

### Back Display

The touchscreen on the Credo digital back is a multifunctional display, where the menus change depending on the status and choices you make.

In addition to providing menu navigation, the display on the back works as a preview screen.



## 2.9 Camera Display Abbreviations

### Liquid Crystal Display

Due to the limitations of the space and letters, words and letters on the LCD are abbreviated.

Display examples of the main LCD

<i>On</i>	→	ON
<i>OF</i>	→	OFF
<i>Err</i>	→	Error
<i>+</i>	→	+ (Plus)
<i>u</i>	→	Under
<i>o</i>	→	Over
<i>n</i>	→	Normal
<i>Loc</i>	→	Lock
<i>SELF</i>	→	Self Timer
<i>bulb</i>	→	bulb
<i>bUSY</i>	→	Busy
<i>db</i>	→	Digital Back
<i>LS</i>	→	Lens Shutter
<i>CAP</i>	→	Capture
<i>rP</i>	→	Repeat
<i>TIME</i>	→	Time
<i>batt</i>	→	battery

Display examples in the custom function mode

<i>SEL</i>	→	Selection
<i>STEP</i>	→	Step
<i>IRIS</i>	→	Iris
<i>HOLD</i>	→	Hold
<i>batt</i>	→	battery
<i>Shot</i>	→	Shot No.
<i>dF</i>	→	Dial function
<i>d.AC</i>	→	Dial action
<i>d.dl</i>	→	Dial direction
<i>AEFL</i>	→	AE, AF lock
<i>HALF</i>	→	Half press
<i>REL</i>	→	AE lock
<i>RFL</i>	→	AF lock
<i>OnEP</i>	→	One-push exposure
<i>AF.L</i>	→	AF assist light
<i>FLSY</i>	→	Flash sync
<i>bu</i>	→	Buzzer
<i>Sh.P</i>	→	Shutter in Program
<i>Sh</i>	→	Shutter in Manual
<i>AF.2</i>	→	AF second mode



## 2.10 The Buttons on the Back

The Credo is equipped with four soft buttons. The buttons change function to match the menu shown on the screen.

## 2.11 LED Lights

Credo series digital backs feature two LEDs. One is located next to the on/off button and the other is inside the CF card compartment.

The red LED indicator located next to the CF card slot (under the cover) is assigned to indicate CF card activity only. Do not remove a CF card from the card slot when this red LED is on. Removing a CF card when the red LED is on can damage the formatting of the card, and images or data might be lost or corrupted.



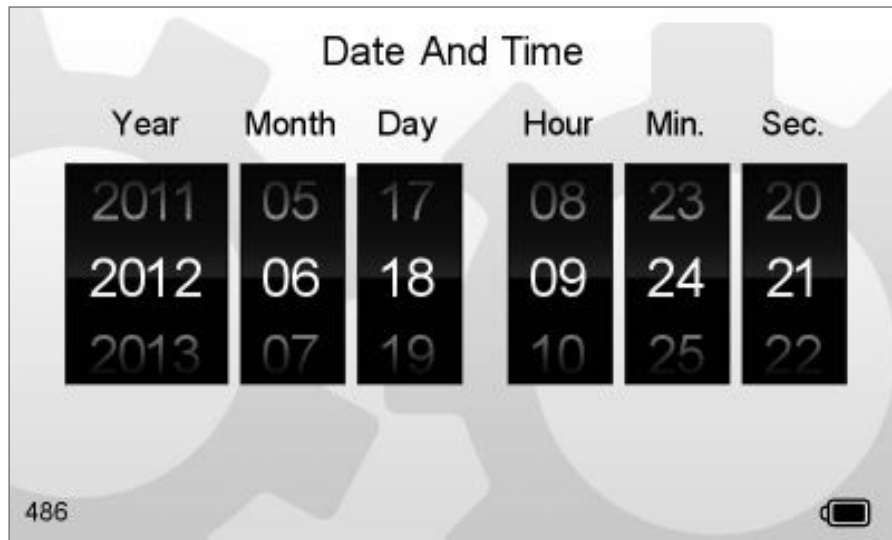

## 2.12 Setting Date and Time

Date and time parameters are set and controlled via the Leaf Credo back's Menu system.

If the Leaf Credo back has been without power for a long period of time, it automatically asks you to set the time and date on the next occasion it is powered up.

Tap the screen and scroll through the numbers to attain the appropriate date and time.

The time and date is applied to the EXIF data in all files captured with the Leaf Credo back.

## 2.13 Setting Diopter

Look through the viewfinder and make sure that the focus frame (rectangle with circle) is in sharp focus. If it is not, turn the diopter adjustment dial in the “-” direction if you are nearsighted or in the “+” direction if you are farsighted. If this is not sufficient you may require an optional diopter correction lens. Check the table for possible diopters.

Point the camera at a bright, plain object such as a white wall when making this adjustment.

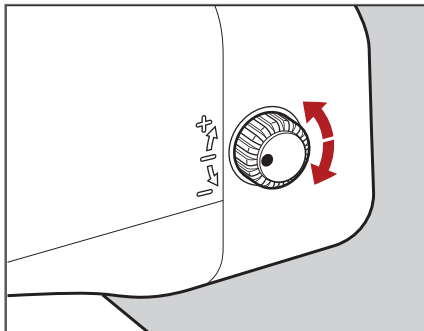

Diopter correction lens	Range of Adjustment
DE401 (standard)	-2,5 to +2,5
DE402 (nearsighted users)	-5,0 to -2,0
DE403 (farsighted users)	0 to +3,0

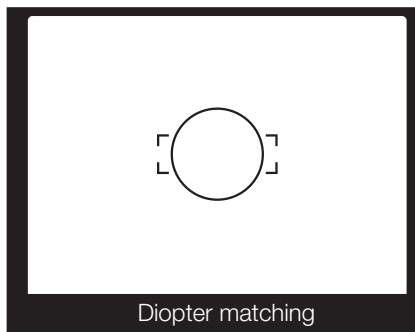
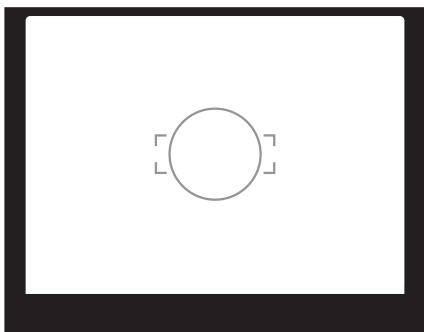

**Notice:**

If there is dirt or dust on the lens surface, remove it with a blower or sweep it off gently with a lens brush

If there are fingerprints or dirt on the lens surface, wipe them off with a piece of clean, soft gauze

Using solvents could discolor the correction lens frame

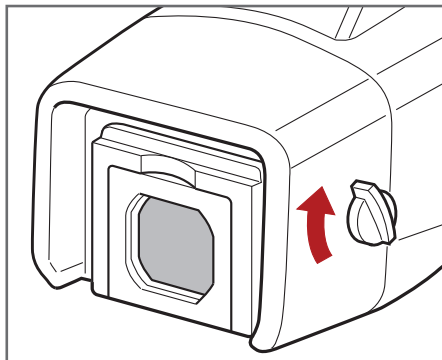
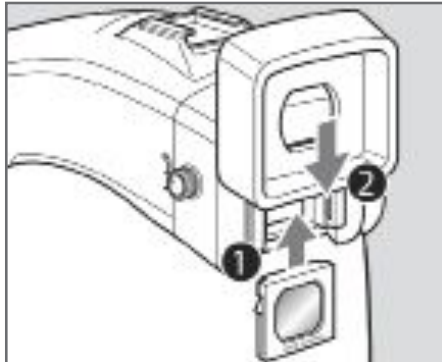
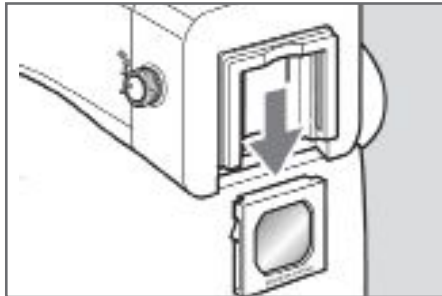
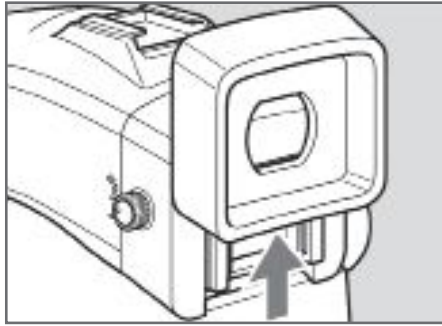

## Replacing the Diopter Correction Lens

1. Press the Eyepiece Lock, which is located in a gap between the Eyepiece and the Diopter Correction lens. (Turn the camera upside down to gain easy access to it). Now remove the rubber Eyepiece by sliding it upwards
2. Remove the lens supplied with the finder by pulling it downward.
3. Remove the existing diopter by sliding downwards using the fingernail groove and detach. Insert a new diopter by aligning it to the base of the diopter holder and sliding it upwards into place. Finish by reattaching the rubber eyecup.

### 2.14 Eyepiece Shutter

Close the eyepiece shutter when there is a strong light source behind the camera or when pressing the shutter release button without looking through the viewfinder. This prevents exposure error due to light entering from the viewfinder.

Turn the eyepiece shutter lever in the direction of the arrow.





## 3.0 Basic Functions



### ISO and White Balance

The Leaf Credo back's Home screen enables quick access to the ISO and white balance (WB) settings by tapping the screen directly. White Balance and ISO settings can also be controlled from Capture One if you are working tethered.

#### 3.1 Setting ISO

The default ISO setting is 50 for all Leaf Credo series models. Remember that the higher the ISO setting, the higher the degree of image noise. The camera system together with Capture One software deliver a powerful noise reduction performance although it is possible to still see some noise at the higher sensitivity settings.

Tap the **ISO** icon on the Leaf Credo back's Home screen. You are presented with the back's ISO spectrum. Tap the screen to select the desired setting. A green frame surrounds the selected ISO and you are returned to the Home screen.

Find out more on ISO operation on page 56.

#### 3.2 Setting White Balance

The default WB setting is Auto. The camera calculates a white balance based on the information in the image. Auto WB is appropriate for most applications where the subject color and lighting are consistent.

Tap the **WB** icon on the Home screen. You are presented with the back's white balance settings. Scroll left or right and tap the icon to select the desired setting. A green frame surrounds the selected WB and you are returned to the Home screen.

Find out more on White Balance operation on page 57.

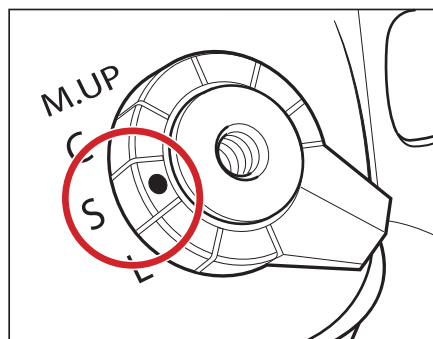
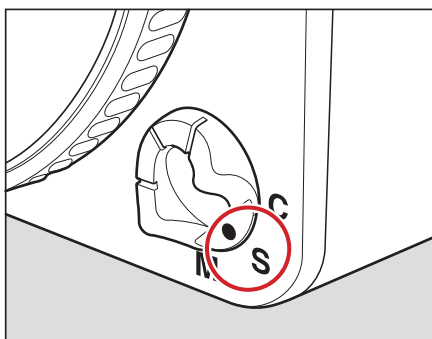

### 3.3 Setting the Shutter Release, Focus, Exposure and Metering modes

1. Set the Shutter Release mode selector lever to **S** (single-frame advance mode).  
There are two shutter release (drive) modes: S (single frame advance mode) and C (continuous advance mode). When set to **L** the power is turned off.
2. Set the Focus mode selector lever to **S** (Single focus mode).  
There are three Focus modes: S (Single focus mode), C (Continuous focus mode) and M (Manual focus mode). See page 29 for more information.
3. Set the exposure mode dial to **P** (Program auto exposure).

#### There are four exposure modes:

**P** (Program Auto Exposure)

**Av** (Aperture Priority AE)

**Tv** (Shutter Priority AE)

**M** (Manual)

**Note:** Av stands for Aperture Value but is referred to as Aperture Priority AE.

Tv stands for Time Value but is referred to as Shutter Priority AE.

Focus Mode		Focusing
S	Single focus mode	Half-press the shutter release button to focus. When the focus mark lights, the focus is fixed and the shutter can be released.
C	Continuous focus mode	The camera keeps focusing continuously while the shutter release button is half-pressed. The shutter can be released regardless of whether or not the focus mark is lit.
M	Manual focus mode	Focus manually.

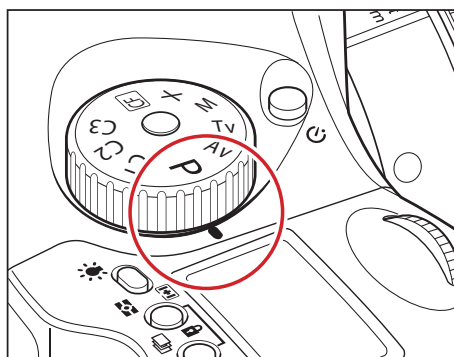

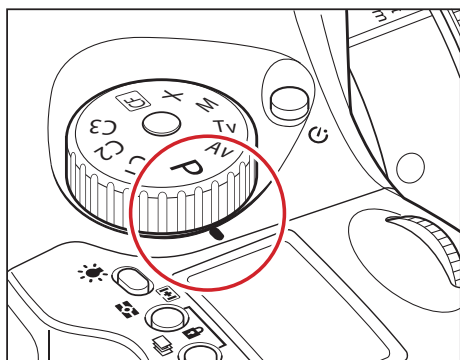

**Notice:**

When a polarizing filter is used, ensure that a circular polarizing filter (C-PL) is used. The correct exposure cannot be obtained with a normal (linear) polarizing filter (PL).

**P:** Program AE — The aperture and shutter speed are determined automatically for the optimum exposure, according to the ambient light conditions. This auto mode is best suited for general photography or for novice photographers, as it leaves the user free to concentrate on framing and capturing the subject.

**Av:** Aperture priority AE — Set the desired aperture and the camera selects the correct shutter speed. Use this mode to control depth of field.

**Tv:** Shutter priority AE — Set the desired shutter speed and the camera selects the correct aperture. Use this mode to stop motion.

**M:** Manual mode — Set this mode to use special combinations of the aperture and shutter speed.

4. Exposure metering mode is automatically set to average/spot exposure metering before exposure metering is performed.

There are three exposure metering modes: In the A mode the average brightness in the entire frame is measured with emphasis on the center of the frame. The brightness at a specific spot in the center of the frame is metered in the S mode. The A-S mode automatically switches between these two modes depending on the contrasts in the picture.

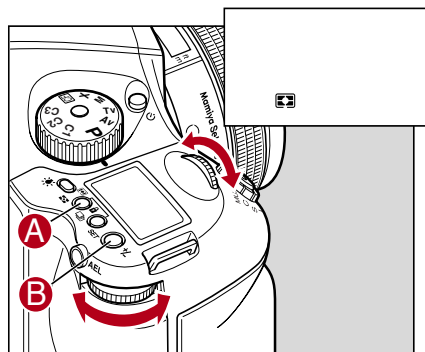
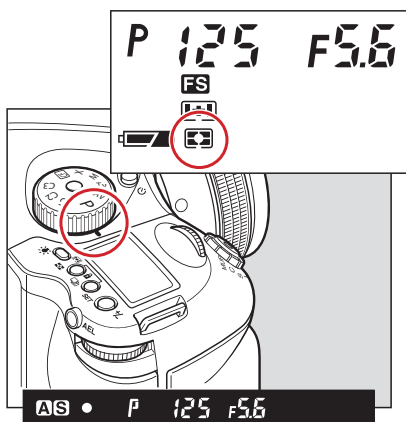

Average/spot auto exposure metering

Exposure metering is performed after automatically selecting average/spot exposure metering.

- Depending on the subject conditions, center-weighted average/spot exposure metering is selected automatically, and the correct exposure is measured.
- Spot exposure metering is automatically selected when the brightness of the spot exposure metering range becomes darker than the brightness of the entire screen.
- If there is very little difference between the spot exposure metering value and center-weighted average exposure metering value, the correct exposure level is obtained as the intermediate value.

Center-weighted average/spot exposure metering

The average brightness of the entire screen is measured, emphasizing the center of the screen.

Center spot exposure metering

The brightness of an area equivalent to 7.6% at screen center is measured, and the exposure is determined. The circle at screen center serves as a general guideline. This mode is suited to measuring subjects with strong contrasts or measuring only screen portions.

Viewer display

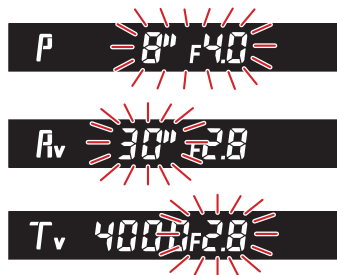

### 3.4 Measuring Light – Exposure Metering

1. Press button **A** to adjust the exposure metering mode. There are three different exposure metering mode options that are displayed sequentially when either the front or rear dial is turned. Select an appropriate exposure mode. Your chosen exposure metering mode is displayed as an icon on the camera's LCD screen.

2. Press the SET button **B** or exposure metering mode button **A** to enter the setting.

#### Exposure Warnings

Users are warned when shooting subjects that are too bright or too dark with an inappropriate exposure setting. At such times, when the correct exposure cannot be obtained, users are alerted by the numeric exposure display that flashes on the external LCD or on the display inside the viewfinder.

Warnings that the exposure is outside the metering range

- **Program AE (P)**  
The shutter speed and f-number blink.
- **Aperture priority AE (Av)**  
The shutter speed blinks.
- **Shutter priority AE (Tv)**  
The f-number blinks.
- **Manual mode (M)**

The exposure metering value difference is displayed.



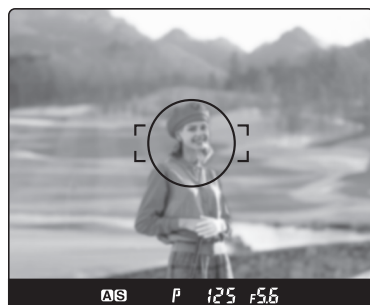
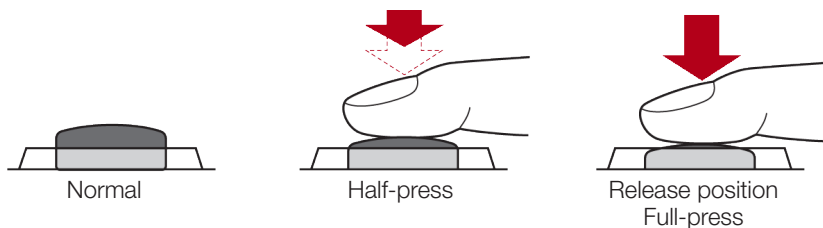

### 3.5 Focus Modes

To use the Auto Focus function, both the camera body and the lens have to be set to their respective Auto Focus modes. Auto Focus does not function when either the camera body or the lens are set to manual focus.

To activate Auto Focus (AF), first select **AF** on the focusing selector ring on the lens. Next, adjust the Focus Mode Selector Lever to either **S** (single) or **C** (continuously) Auto focusing on the camera. The Focus selection ring on the lens can help you to rapidly switch between AF and M, without having to change your grip of the camera.

The shutter release button has a two-step action. When pressed lightly it stops at a certain point. In this manual, this position is called the **half-press** position. When you **half-press** this button, the camera functions are activated. When the shutter button is pressed further down, the shutter is released. This position is called the **full-press** position.

1. Aim the camera so that the subject is within the focus frame.
2. Half-press the shutter release button, and focus is adjusted automatically in AF mode. As default, you can now re-compose your image without losing the original focus setting, by moving the camera and keeping the shutter release button half-pressed. When the focus mark lights up, the subject is in focus.
3. When the focus mark lights up, press the shutter release button further down to release the shutter. (The focus mark is an illuminated dot (indicated as this • symbol) at the bottom of the viewfinder display. See the focus mark in the illustration circled in red).

#### Out of Focus Marks ▶ ◀

When the picture is not focused the shutter cannot be released when in single focus mode. Either press the shutter release button again to adjust the focus or move the camera to change the position of the focus frame. Lenses without the focus mode selector ring are automatically set to AF if the camera is set to Auto Focus. Do not touch the focus ring as you may cause internal damage to the camera Auto Focus motor.

#### Lenses with the Focus Mode Selector

The focus modes can be switched between automatic and manual with the selector on the lens when the focus mode selector lever on the camera body is set to S or C.



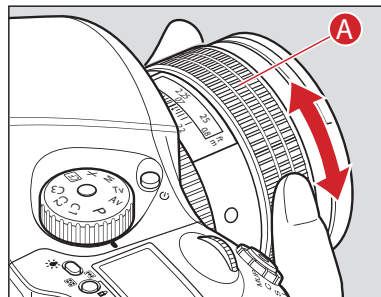
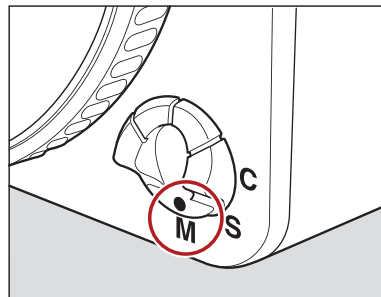
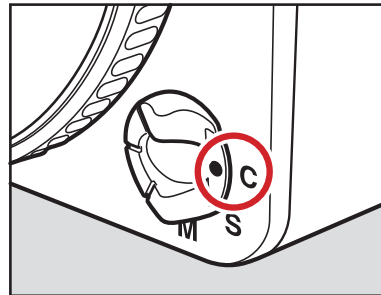
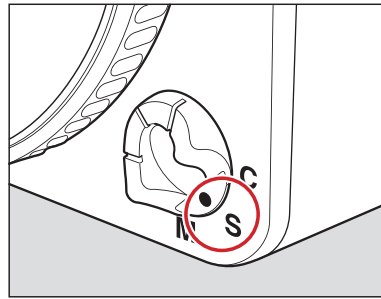

### Single Focus Mode (S)

This mode uses the focus-priority mechanism. The shutter can be released when the focus mark • in the viewfinder is illuminated. This mode is suited for still subjects. Focus is locked when the focus mark • is illuminated in the viewfinder's LCD.

The shutter cannot be released if the subject is not in focus (if the focus mark • does not illuminate).

To take another photo with a different composition, take your finger off the shutter release button then re-press the shutter release button again.

### Continuous Focus Mode (C)

In this mode shutter release has priority to focusing. The shutter can be released regardless of whether the focus mark • in the viewfinder's display is illuminated. Focus is adjusted continuously while the shutter release button is half-pressed. This mode is suited for moving subjects.

Focus is not locked even if the focus mark is lit.

The shutter can be released even if the focus mark is not lit.

### Manual Focus Mode (M)

To attain full manual control of the focus function you can change to manual focus mode in two ways.

- 1. All lenses:** Turn the focus mode selector lever to **M** (Manual focus mode).
- 2. Manual Focus operation for telephoto and zoom lenses:** All newer Mamiya, Phase One and Schneider-Kreuznach lenses can be switched from Auto Focus to Manual Focus by using the AF ring or slider fitted on the lens.

For lenses with AF slider, slide the focusing ring on the lens backward until it clicks. When this is done, the Auto Focus inscription on the lens barrel is covered and the lens can then be focused manually. For lenses with an AF ring, simply rotate the AF ring to the MF position to select manual focus.



In focus



Turn focus ring clockwise



Turn focus ring counter clockwise

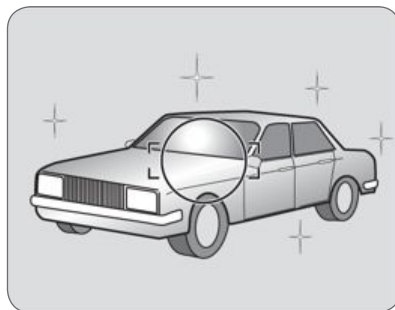
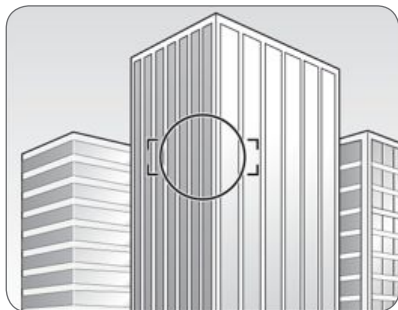
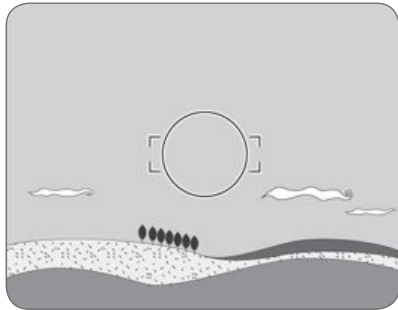

## Manual Focusing using the Focus Mark (Focus confirmation method)

Half-press the shutter release button and turn the lens focusing ring to focus on the subject. The focus mark is illuminated in the viewfinder's LCD to signal that a picture is in focus.

If ► is lit in the viewfinder's LCD, the camera is focused on a point behind the object.

If ◀ is lit, the camera is focused on a point in front of the object.

- Use the focus mark when taking photos in manual focus mode or when using the M645 manual lens.
- If you adjust focus using the focus mark with an M645 lens, make sure to open the aperture. You can use this function with the lens set to f/5.6 or higher.

## When Auto Focus Fails

The auto focus function requires contrast in the subject. Auto focusing may fail to achieve focus with certain subjects described below. In such cases, either switch to the manual focus mode (and focus manually) or focus on a more contrast appropriate object at the same distance as the object you want to photograph, lock the focus using the focus lock button on the front of the camera body, then take a picture.

- Low-contrast subject (blue skies, white walls and other objects)
- Two or more objects overlapping at different distances within the focus frame (animals in cages, etc.)
- Subjects with continuous repeated patterns (building exteriors, blinds, etc.)
- Extremely backlit reflective subjects (car bodies, water surfaces, etc.)
- Or when the subject is far smaller than the focus frame

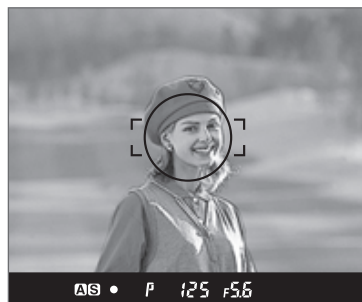

**Notice:**

Effective range of the AF assist infrared light is limited. It does not reach distant subjects. — Range:

9 m/29.5 ft (using 80 mm f/2.8 lens)

Use of a lens hood or a bellows lens hood (sold as an optional accessory) may interfere with the assist light. It is advisable to set the focus before mounting the hood.

The AF assist infrared light can be disabled.

### 3.7 Using Focus Lock and Infrared Focusing

Use the focus lock when your intended focus point is not within the focus frame. In such cases where a subject is not located in the center of a frame, use the focus lock function to lock the focus before releasing the shutter.

**1. Set the focus mode selector lever to S or C.**

Put the subject in the focus frame and half press the shutter release button.

**2. Lock the Focus.**

When the focus mark • in the viewfinder LCD is lit, press the AF lock button on the front of the camera to lock the focus.

**3. Adjust the Composition.**

With the shutter release button half-pressed, slide the camera to achieve the desired composition, and release the shutter.

When the focus mode is set at **S** (Single focus mode) and the focus mark • is lit, hold the shutter release button halfway down to lock the focus.

#### AF Assist Infrared Light

Autofocus can fail when a subject is dark or very low-key. On these occasions, a red lamp may be activated on the front of the camera when the shutter release button is half-pressed to assist the camera's auto focus function. The AF assist infrared light is emitted only when the focus mode is set to S (Single focus mode).

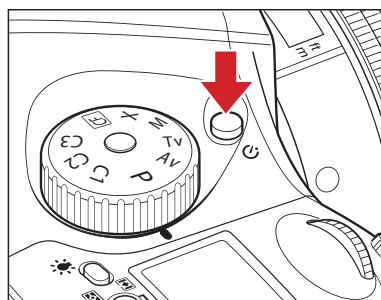
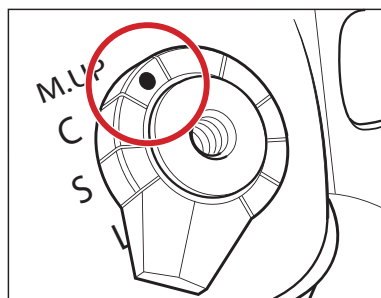
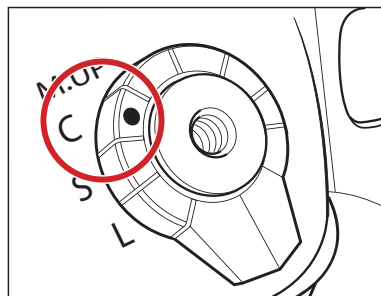
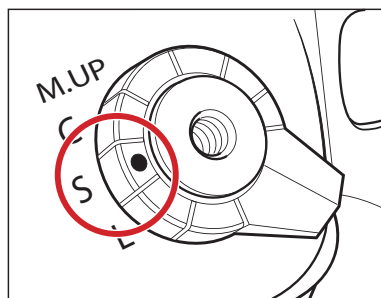

## 3.8 Drive Dial

### Single-Frame Mode

One photograph is taken each time the shutter release button is pressed.

Set the shutter release mode selector to **S**.

### Continuous Mode

Photographs are exposed as long as the shutter release button is pressed.

Set the shutter release mode selector lever to **C**. Photographs are taken continuously at a rate depending on the buffer speed of the digital back mounted on the camera.

### Mirror Up Mode

When the shutter button is pressed, the mirror moves up, and when the shutter button is pressed again, the shutter is tripped and a picture is taken.

### Self-Timer Mode

In this mode, the shutter is released 10 seconds after the shutter release button is pressed.

Activate the Self-timer by pressing the  button. Next, rotate the front dial so that **On** is displayed in the camera's LCD and press the shutter release.

When the shutter release is pressed, the Self-timer lamp blinks continuously for seven seconds, followed by three seconds of rapid blinking until the camera releases the shutter.

**Notice:**

If a correct exposure cannot be obtained, the shutter speed and aperture value blink. In such cases, the pictures can be taken, but they may be too bright or too dark.

If the shutter speed and aperture values blink on the main LCD and in the viewfinder display when the program line is shifted, the proper exposure cannot be achieved.

Select a different program mode.

When the Program line is shifted, the aperture value changes along with the shutter speed to maintain the proper exposure.

Increment of the aperture and shutter speed can be set at either 1/3- or 1/2-stop.

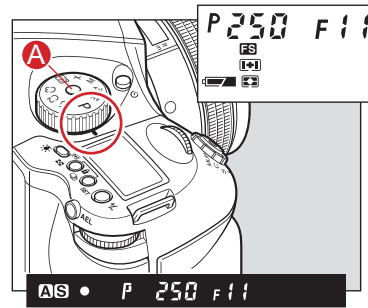

### 3.9 Exposure Modes

#### (P) Program AE

The aperture and shutter speed are determined automatically for the optimum exposure, according to the ambient light conditions. This auto mode is best suited for general photography or for novice photographers, as it leaves the user free to concentrate on framing and capturing the subject.

Alter the shutter speed and aperture by turning the front and rear dials while the **P** (Program AE) mode is selected.

#### Program Shift (PH/PL)

The shutter speed and aperture can be altered by turning the front and rear dials while the **P** (Program AE) mode is selected. In order to avoid blurred images (due to camera shake while releasing the shutter), or to open the aperture, change to **PH** (high speed). For slower shutter speeds and wider depth of field, change to **PL** (low speed). This function allows these changes to be made quickly.

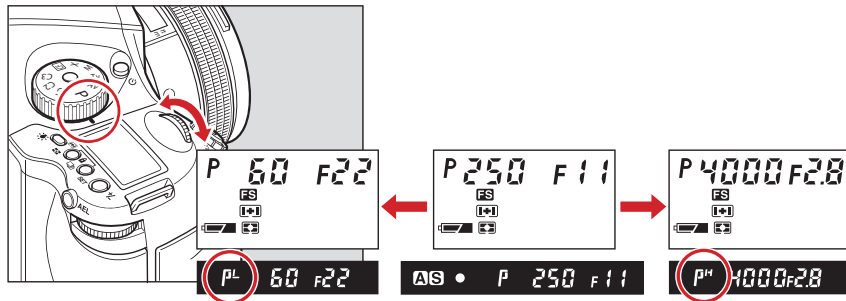

Mamiya 645 program shift chart

(ISO100/AF80mm F2.8 D)

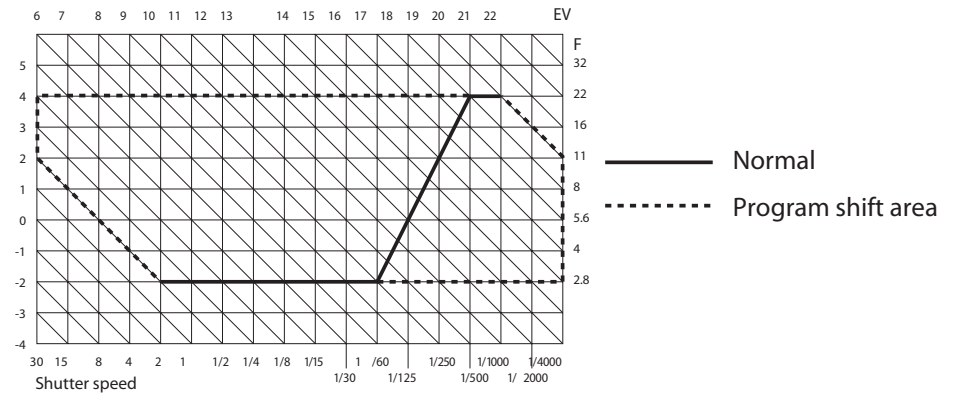

**Notice:**

The shutter speed value blinks when the subject is too dark or too bright for a correct exposure. To obtain the correct aperture, adjust the aperture value until the shutter speed value stops blinking and remains lit.

When the exposure is compensated with the rear dial, the aperture can be set with the front dial only.

Increment of the aperture can be set at either 1/3- or 1/2-stop.

Rotation direction of the dials to change the values can be altered.

The selected aperture level can be locked.

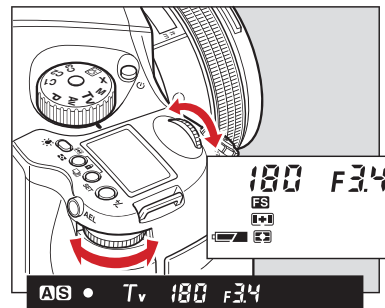
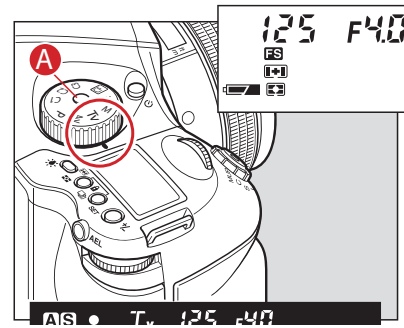
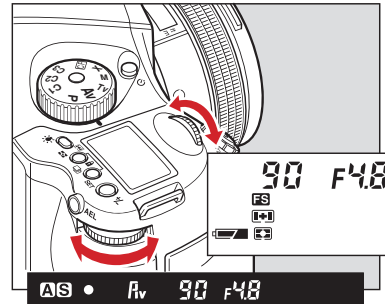
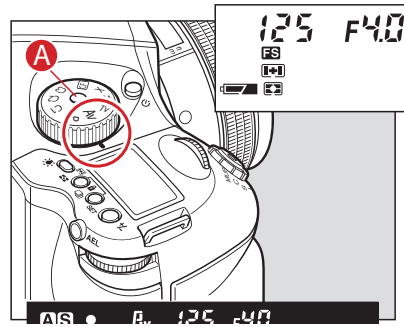

**Notice:**

The aperture value blinks when the subject is too dark or too bright for a correct exposure. To obtain the correct aperture, adjust the shutter speed value until the aperture value stops blinking and remains lit.

When the exposure is compensated with the rear dial, the shutter speed can be set with the front dial only.

Increment of the shutter speed can be set at either 1/3- or 1/2-stop.

Rotation direction of the dials to change the values can be altered.

The selected shutter speed can be locked.

### Aperture Priority AE (Av)

Set the desired aperture, and the camera selects the optimum shutter speed accordingly. Use the Av mode to maintain specific control over depth of field,

1. Turn the exposure mode setting dial to **Av** (Aperture priority AE) position.
2. Turn the front or rear dial to set the desired aperture.

### Shutter Priority AE (Tv)

Set the desired shutter speed and the camera selects the optimum aperture accordingly. A fast shutter speed can be used to freeze motion and slow shutter speed can be used to create motion blur.

1. Turn the exposure mode setting dial to **Tv** (Shutter priority AE) position.
2. Turn the front or rear dial to set the desired shutter speed.



**Notice:**

When the exposure is compensated in the Manual mode, the difference between the metered value and the compensated value is displayed on the viewfinder LCD. In the B (Bulb) mode, the difference with the metered value is not displayed.

Increment of the aperture and shutter speed value can be set at either 1/3 or 1/2 stop.

The assignments of the front and rear dials can be swapped.

Rotation direction of the dials that change the values can be altered.

The selected aperture and shutter speed can be locked.

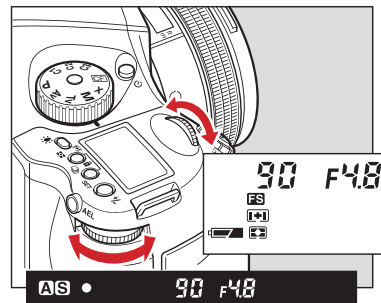
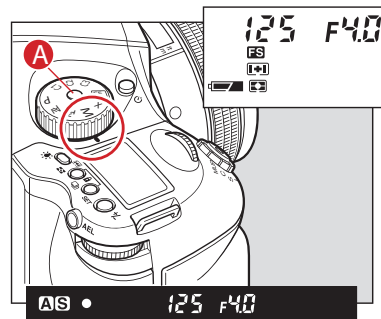

**Notice:**

When the set value matches with the metered value, the difference indicator shows **0.0**.

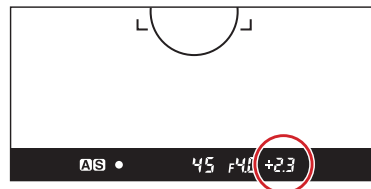

## Manual Mode (M)

This mode is used to set both the aperture and shutter speed for total exposure control. Varying shutter speeds can be selected, including **Bulb**, **TIME** and manually from 60 minutes to 1/4000 second. Aperture values can be set from maximum to minimum aperture.

1. Turn the exposure mode setting dial to **M** (Manual) position.
2. Turn the rear dial to set the desired aperture.
3. Turn the front dial to set the desired shutter speed.
4. When the shutter release button is half pressed, the difference between the present settings and the metered value is displayed in the viewfinder's LCD panel. The value is displayed in 1/3 stop increments within a range of  $\pm 6$  EV.

When the difference between the set value and the metered value is greater than  $\pm 6$  EV and the set value is lower than the metered value, the indicator in the viewfinder LCD shows “- u -”. Contrarily when the set value is higher than the metered value, the indicator shows “- o -”.

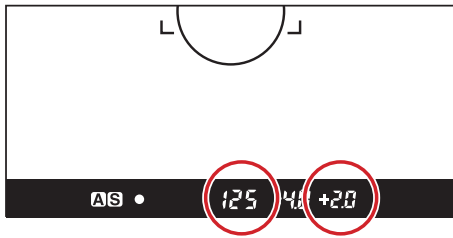

**Notice:**

The aperture level can be selected for the parameter to shift.

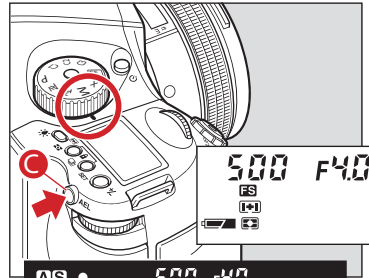

**Notice:**

Photography using the leaf shutter or focal plane shutter can be selected in custom settings

**Notice:**

The selected aperture value can be locked.  
When 1/800 sec shutter speeds can't be achieved, even though a leaf shutter lens is attached, try another exposure mode.

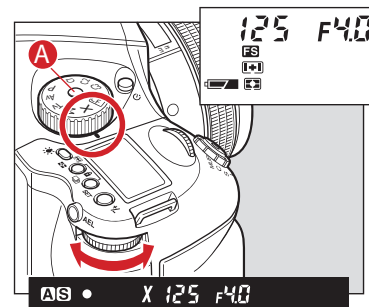

### One-push Shift Function

When the difference between the set value and metered value is displayed on the viewfinder LCD in the Manual **M** mode, press the **AEL** button for approximately one second and the camera automatically adjusts the shutter speed to achieve the correct exposure based on the set aperture value.

While the difference **B** between the set value **A** and the metered value is displayed on the viewfinder LCD, press the **AEL** button **C** for approximately one second. The camera changes the shutter speed to an appropriate level.

### Auto Mode Mechanism

A leaf shutter's working range is from 1/800 sec to 1 sec. To achieve other speeds (1/4000 to 1/800 sec, 1 to 60 sec, bulb) the camera automatically switches to the focal plane shutter.

### Sync Mode (X)

Select this mode when a flash is used. Choose **X** and the shutter speed is fixed at 1/125 sec for synchronization.

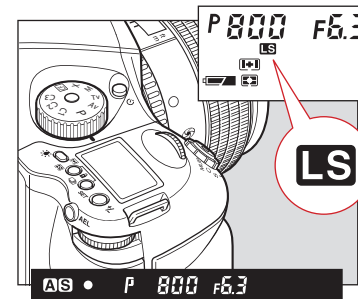

## Shutter Types and Flash Synchronization Options for Shutter Modes

Exposure Mode	Lens Mode	Shutter speed			X-Sync		
		1/4000 – 1/800	1/800 – 1S	1S – 30S+	1/4000 – 1/800	1/800 – 1S	1s – 30S+
Program	Leaf Shutter	—	LS	—	—	LS	—
	Focal Shutter	FS	FS	FS	—	1/90 – 1S	—
Tv	Leaf Shutter	—	LS	—	—	LS	—
	Focal Shutter	FS	FS	FS	—	1/90 – 1S	FS
Av	Leaf Shutter	—	LS	—	—	LS	—
	Focal Shutter	FS	FS	FS	—	1/90 – 1S	—
Manual	Leaf Shutter	—	LS	—	—	LS	—
	Focal Shutter	FS	FS	FS	—	1/90 – 1S	FS
	Auto	FS	LS	FS	—	LS	FS
X	Leaf Shutter	—	1/125,90,60	—	—	1/125,90,60	FS
	Focal Shutter	—	1/125,90,60	—	—	1/125,90,60	—

### 3.10 Flash Photography

The Mamiya 645DF+ is equipped with a vertical-travel focal plane metal shutter and it is also compatible with leaf shutter lenses.

The focal plane shutter provides higher shutter speeds than that of leaf (central) shutter lenses. Focal plane shutters allow you to shoot fast enough to freeze moving subject matter. Leaf shutter lenses allow faster shutter synchronization to flash, making it ideal for freezing subject movement when using strobe lighting.

The focal plane shutter method allows for shutter speeds of up to 1/4000 sec. When shooting at higher speeds e.g. 1/500 sec the two shutter blades are moving in parallel creating a small slit allowing a small fraction of light to reach the sensor area of the digital back. When using this type of shutter it is not possible to achieve flash synchronization greater than 1/125 sec.

A leaf shutter makes it possible to achieve faster shutter and flash sync speeds. A Leaf Credo series back can sync at maximum shutter speed of 1/1600 second.

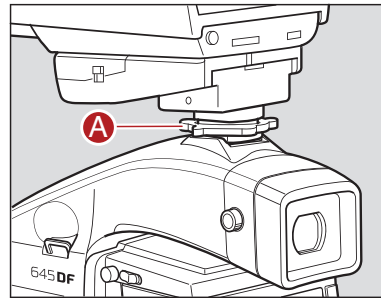

**Notice:**

This camera's sync contact is an X contact.

Using flashes designed exclusively for other camera manufacturers in the hot shoe may damage the camera's internal mechanisms. In this situation, use an off-camera flash bracket and connect a sync cord to the camera's sync terminal.

When using flashes with a flash duration of 1/500 sec or longer, set the shutter speed to 1/30 sec or less.

1. A grip type flashgun or a strobe (with electric contacts other than X contact) can be operated with the Mamiya 645DF+ by connecting a sync cord into the camera's sync terminal. See the note on the left side of this page about flash units designed exclusively for other camera makes.
2. Turn the exposure mode setting dial to **X** (1/125 sec) or **M** (Manual). When **M** (Manual) is selected, turn the front dial and set the shutter speed to 1/125 sec or slower.
3. Turn the rear dial to set the aperture, and then press the shutter button to take a picture.

In addition to its standard flash sync system, the Mamiya 645DF+ features TTL (through the lens), off the film/sensor (OTF) and electronic flash exposure metering.

## Metz 3952 functions

<b>Charging completed indicator in viewfinder</b>	When charging of the flash is completed, a charging completed flash icon ⚡ is illuminated in the viewfinders display panel.
<b>Automatic setting of flash synchronizing speed</b>	When exposure mode is set at <b>Av</b> or <b>P</b> , the shutter speed is automatically set to 1/60 to 1/125 sec when charging of the flash is completed.  When exposure mode is at <b>Tv</b> or <b>M</b> and the shutter speed is faster than 1/125 sec, the shutter speed is automatically set to 1/125 sec.
<b>Flash confirmation</b>	The flash charge mark ⚡ flashes after the shutter is released to indicate that the flash was emitted properly.
<b>Auto zoom control</b>	The power zoom reflector is linked to the lens focal length (excluding the Metz 32Z-2).
<b>Auto AF assist beam</b>	When the focus mode is set to <b>S</b> , the autofocus assist beam is emitted automatically in low light (excluding the Metz 32Z-2).
<b>Display of flash range (distance)</b>	Displayed on the flash's liquid crystal display panel (Metz 32MZ-3 and Metz 32Z-2).
<b>Data transfer</b>	The ISO data, exposure compensation data and aperture data are sent from the camera to the flash.

Metz Flash Unit	Adapter		
	Type of flash	SCA 3952 Module	Converter
Metz 44 MZ-2	Shoe-mount	x	
Metz 54 MZ-3	Shoe-mount	x	
Metz 45 CL-3 & 4 Digital	Handle-mount	x	SCA 3045
Metz 60 CT-4	Handle-mount	x	SCA 3000
Metz 70 MZ-5 & 4	Handle-mount	x	

For more info on Metz, contact the local Metz dealer or [www.metz.de](http://www.metz.de)

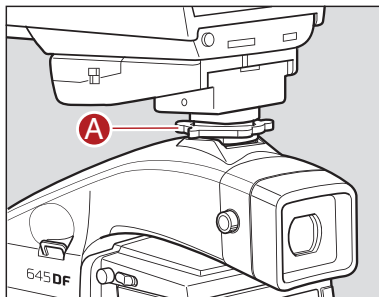

Mamiya 645DF+ features Through the Lens (TTL), Off the Film/Sensor (OTF) and electronic flash exposure metering. A flash sensor located inside the camera body reads the flash light reflected off the surface of the CCD at the moment of exposure. The sensor is connected via the Mamiya 645DF+'s dedicated hot shoe to a shoe or handle-mount style Metz flash unit via the Metz SCA 3952 TTL Adapter. Maximum flash speed is 1/125 second when the focal plane shutter is used, making daytime synchronization possible.

The ISO of the flash is automatically set through the TTL connection from the digital back; any adjustment to this is instantly recognized after the setting is locked and the shutter release is half-pressed.

To utilize the TTL flash feature with all TTL-operable Metz flash units, a Metz SCA 3952 module is required. See the chart for capability and/or additional adapters that may be necessary.

The resulting flash exposure automation determines correct flash exposure and automatically adjusts the output of the flash. It also automatically corrects for exposure compensation normally required when using filters, close-up bellows or extension tubes.

1. Mount the SCA 3952 adapter onto the Metz flash, insert fully into the camera's hot shoe, and then tighten with the locking knob **A**.
2. Set the exposure mode, and then check the shutter speed and aperture.

Exposure mode		Shutter speed	Aperture
<b>P</b>	Program AE	Automatically set by camera to 1/60 sec when the metered shutter speed is 1/60 or slower, and 1/125 when it is 1/125 sec or faster.	Automatically set by camera
<b>Av</b>	Aperture priority AE		Any aperture
<b>Tv</b>	Shutter priority AE	Automatically set by camera to 1/125 when the set shutter speed is 1/125 sec or faster.	Automatically set by camera
<b>M</b>	Manual mode		Any aperture
<b>X</b>	Sync mode	1/125 sec or via CF	Any aperture



## TTL flash

With TTL flash photography, the reflection of the flash is metered and the intensity of the flash is adjusted automatically, which can mean TTL flash photography may not be suitable for all shooting conditions. In the cases described below, we recommend that you use a flash meter to check the intensity of the flash or use a manual flash setting.

### Example:

1. When the size of the subject you want to light with the flash is relatively small within the picture
2. When the background behind the subject is extremely bright or when there is a strongly reflective object in the background
3. When the background behind the subject is extremely dark (outdoors at night, etc.)
4. For flash photography with a narrow sensitivity latitude

## Curtain Sync

When a moving subject has been shot under this function, the flash of light appears after the moving subject.

Rear curtain sync mode.

Front curtain sync mode.

This function is set by Custom function setting. Go to page 103 for more information.



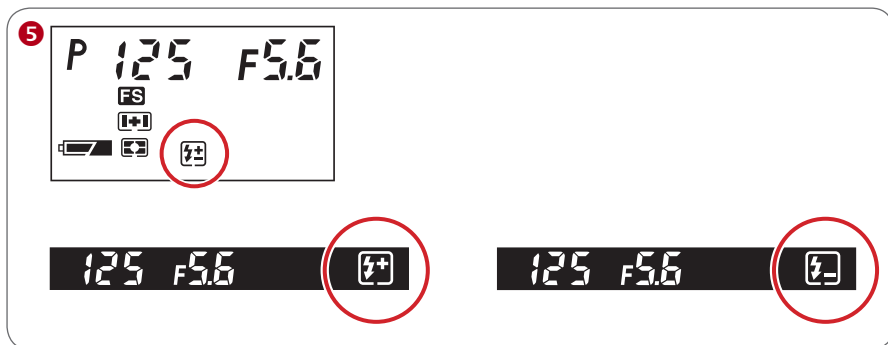
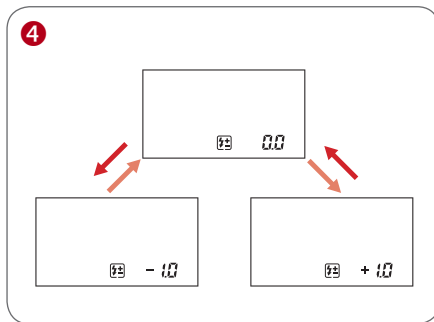
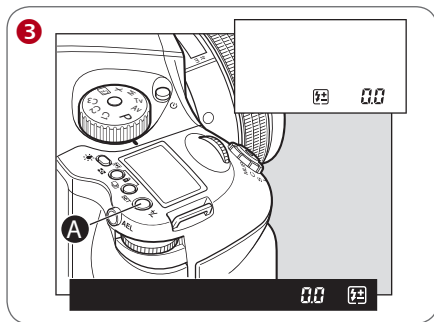
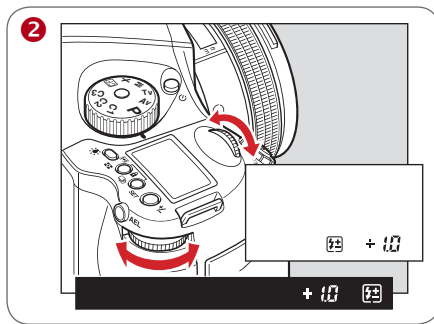
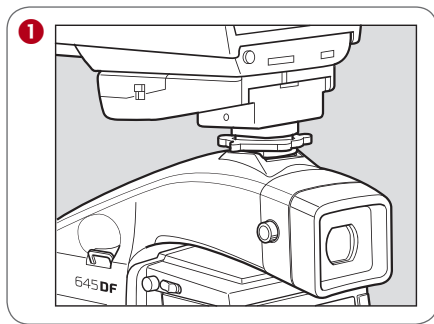

### 3.11 Flash Compensation Settings

By combining a Metz flash and the SCA 3952 adapter, the camera adjusts for flash. It can be adjusted within  $\pm 3\text{EV}$  in increments of  $1/3$  steps.

1. Turn on the Power.  
Install the SCA 3952 adapter on the Metz flash, and attach it to the camera. Lock the flash in place using the locking knob on the flash shoe. Turn the shutter release mode selector lever to the **S** or **C** position, and turn ON the flash power switch.
2. When the flash charge confirmation lamp lights, press the set button **A**. The icon is displayed on the main LCD panel.
3. Turn the front or rear dial to select the flash compensation value. External LCD Panel (normal display).
4. When the shutter button is half-pressed, the display appears on the external LCD, and appears on the LCD inside the viewfinder with a + compensation, or appears with a - compensation.

#### Viewfinder LCD Readouts

- If the flash-charge mark is not displayed, the flash compensation button **A** cannot be used.
- Keep pressing the set button to activate the flash compensation mode. You can check the exposure compensation value.
- If you turn the shutter release mode selector lever to the **L (power OFF)** position, the compensation value is cancelled.

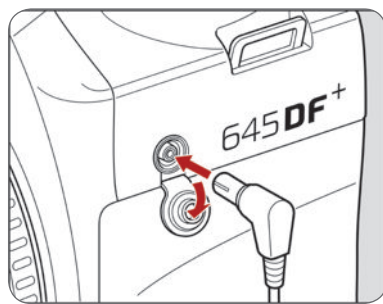

**Notice:**

Using flashes designed exclusively for other makers' cameras may damage the camera's internal mechanisms if connected to the camera's hot shoe.

In this situation, use an off-camera flash bracket and connect a sync cord to the camera's sync terminal.

- When using flashes with a flash duration of 1/500 sec or longer, set the shutter speed to 1/30 sec or less.

## Flash Photography with Electronic Flash Models other than Metz units

1. To use a grip type flashgun or a strobe with electric contacts other than an X contact, connect the sync cord to the camera's sync terminal.  
(See note below about flashes designed exclusively for other makers' cameras.)
2. While pressing the **unlock** button, turn the exposure mode setting dial and set it to **X** (1/125 sec) or **M** (manual).  
When **M** (manual) is selected, turn the front dial and set the shutter speed 1/60 to 1/125 sec or slower.
3. Turn the rear dial to set the aperture, then take the picture. (For M, use the rear dial. For X, use the front dial).

This camera's sync contact is an X contact.



**Mamiya** leaf



## 4.0 Introduction to the Credo Series Digital Back

### System Overview

The Leaf Credo series digital back is designed to fit on the Mamiya 645DF+ as well as several other brands or models of medium format cameras.

The Leaf Credo series include three different models; the Credo 80, 60 and 40 that feature maximum resolutions of 80, 60.5 and 40 high quality megapixels respectively. All of the backs have a dynamic range of 12.5 f-stops. The Leaf Credo backs employ both USB 3.0 and FireWire 800 connections, facilitating fast image transfers. All three models also incorporate a newly designed 3.2 in touch display that features 1.15 megapixel resolution. The wide format display allows for a full 4:3 aspect ratio image next to a histogram, highlight warning, file info and touch controls. This touchscreen display is complemented by Mamiya Leaf's intuitive 4 soft button navigation.

The following section deals with generic features that are available in all three Credo series digital back models.





## 4.1 Quick Start (shooting untethered)

1. Connect a Leaf Credo digital back to the camera and install the focusing screen if applicable.
2. Charge the battery (see page 12), then insert it into the back and either a Li-Ion rechargeable battery pack or AA batteries into the camera.
3. Insert a CompactFlash card into the Leaf Credo back.
4. Switch on the power to the back and camera and select a drive mode.
5. Choose an exposure mode.
6. Select a focus mode on the camera body and lens if applicable.
7. Set the date and time (see page 21).
8. Set the ISO and White Balance (see page 24).
9. After shooting, transfer images into Capture One software from the CF card using a card reader.
10. Edit images in Capture One and output as required.



## 4.2 General Hardware Setup

### Powering up the Leaf Credo back

After a Leaf Credo back is connected to a camera body, insert a battery, USB 3.0 or FireWire 800 cable and it automatically turns on. The back is switched on/off by pressing the power button located at the top of the Leaf Credo back.

### ISO Settings

The Credo 80 back has a default ISO range from ISO 35-800. The Credo 60 and Credo 40 have a default ISO range from ISO 50-800, and the new Credo 50 has a default ISO range of ISO 100-6400. An ISO rating can be selected from the menu system (when untethered) or in the Capture Tool in Capture One Pro software (when tethered).

### Shutter Latency

The default setting is Normal Latency, which should remain unchanged under all 'normal' shooting scenarios. Only change the setting to **Zero Latency** if you work on technical cameras, large format cameras or certain manual cameras in special situations.

### Double Exposure Protection

It is not possible to accidentally double expose an image by capturing one shot quickly after another when a Leaf Credo back is used on cameras such as the Mamiya 645DF+/AF/AFDIII, Phase One 645DF+, Hasselblad 555 ELD (DIG mode), Hasselblad H or Contax 645. The electronic communication with the body ensures that the Leaf Credo back is ready before allowing release of the next shot. However, users of other camera bodies that do not use the electronic interface from the Credo have to wait for the ready beep signal before releasing the next shot.





### 4.3 Indicator Light

Credo series digital backs feature an indicator LED located beside the on/off button. When the Leaf Credo back is in sleep mode, the green LED is illuminated. The LED goes out as soon as the back is activated. In general, if the LED is not illuminated and the back and camera are on, the camera is ready.



### 4.4 CF Card LED

There is an additional red LED indicator located next to the CF card slot (under the cover). It indicates CF card activity. Do not remove a CF card from the card slot when this red LED is on. Removing a CF card while the red LED is on can damage the formatting of the card, and images or data might be lost or corrupted.



## 4.5 Tethered and Untethered Operations

**Untethered:** A Leaf Credo series back can be operated as a fully portable battery powered unit. Image files are shot and transferred to a CompactFlash card which is inserted in the CF card slot on the left side of the camera back.

**Tethered:** Remember to always keep a battery in the Leaf Credo back even when shooting tethered to a computer via a FireWire connection. When operating tethered, image files can be shot to a CompactFlash card or transferred directly to the assigned capture folder in the Capture One application on the computer hard disk. (See page 80 for more details about charging the battery when tethered to a computer).

### Driver Set-up

Find out more on installation and activation of software on page 8 and 9 of this User Guide. There is no specific program set-up. Check the Capture One User Guide for recommended hardware. Firmware announcements are available on our website, and in our newsletters.

### Connecting

The maximum length of a compatible FireWire cable is 4.5 meters. Longer cables might require a third party power solution or a FireWire hub. Leaf Credo series backs match the FireWire 800 standard.

Plug the FireWire 800 cable into the Credo unit and into the back of your Mac or Windows PC. (It is not recommended to use a FireWire port on the front of a computer as it can be less stable). Capture One automatically recognizes the Leaf Credo back and settings. Read more on shooting tethered in the Capture One software manual.

**Note:** Leaf Credo backs are compatible with FireWire 400. Order a Mamiya Leaf FireWire 800 to 400 cable 4.5 m. Part no: 50300164.

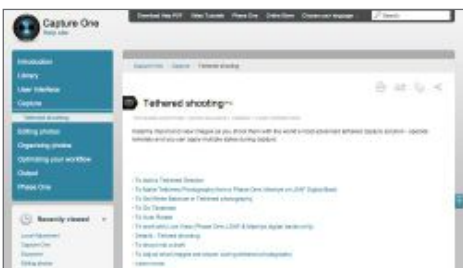

## Tethered Operations Continued

The display on a Leaf Credo series back can be either be turned off while shooting tethered or set to display the images while they are shot, just as if shooting untethered. It is also possible to enlarge a section of an image on the Credo screen to help check focus of the current and upcoming captures.

A Leaf Credo back defaults to its untethered mode when the FireWire 800 or USB 3.0 cable is removed in its Auto Storage setting. Captured image files are stored on a CompactFlash card, and the unit's battery provides power.

The Leaf Credo back can be forced to shoot to either CompactFlash, or via a USB 3.0 or FireWire 800 cable to a computer. Find out more on the Storage Mode on page 81.

## Online Support

For more information on shooting tethered with Capture One, consult the online user guide available in the Capture One Help menu.

## 4.6 CompactFlash Card Usage

It is important to follow a few simple guidelines to help avoid loss of data when working with CompactFlash cards, card readers and digital cameras. Mamiya Leaf recommends that you test-drive all new CompactFlash cards with your Leaf Credo back. By performing an initial test to verify that the capture files are stored properly on the card and can be accessed on a computer you avoid unpleasant surprises on location or when you return from a job. CompactFlash cards are manufactured by other suppliers and Mamiya Leaf cannot guarantee that the cards are not defective.



### Inserting and Ejecting on the Leaf Credo Back

The CompactFlash card is inserted in the slot located under the cover on the left-hand side of the Leaf Credo back.

Insert the CompactFlash card with the brand label facing the display end of the digital back as shown in the image.

The cover can be closed when the CompactFlash card is fully inserted.

To eject the card push the small button above the card once, and an ejecting pin comes out. Pushing this pin all the way back in ejects the card.

Microdrives are not recommended for use with Leaf Credo backs.

## 4.7 Secure Storage System (3S)

You can always be sure that your data is safe when working with memory cards in a Leaf Credo back. The Mamiya Leaf Secure Storage System (3S) provides the industry's safest memory card handling. The 3S technology automatically checks your card's file structure every time it is inserted into the Leaf Credo back. If the Check Disk function finds an error, it prevents usage of the card until it is corrected or the card is formatted.

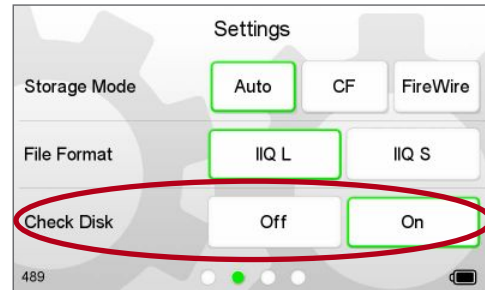

### How does 3S work?

A complete disk check for a valid file structure is performed as soon as a card is inserted into the Leaf Credo back.

Lower gigabyte capacity cards load quicker than high capacity versions.

It is not recommended to turn off the Check Disk function. If you want to turn it off go to Home > Settings > Check Disk.

### Disk Check Summary

3S technology is a safe storage system integrated into the Leaf Credo back and is much more rugged than anything else seen in the industry. DSLR cameras do not have this level of storage security.

Benefits include:

- No need to format a card on a computer.
- Damaged or incorrectly formatted cards are detected immediately. Leaf Credo backs also have the ability to reformat and correct these cards.
- Ejecting a card while it is writing a session does not necessarily damage the file structure of the entire CompactFlash card. Only the image being written and the images in the buffer can be damaged.



## 4.8 Formatting your Memory Card

Most CompactFlash cards are preformatted and ready for use in the Leaf Credo backs. However, Mamiya Leaf recommends that all cards be formatted in the Leaf Credo back to ensure their optimum performance.

Memory card formatting is done in either FAT 16 or FAT 32 depending on card size. (Leaf Credo backs support CompactFlash cards formatted in both FAT 16 and FAT 32.)

### Using CompactFlash Cards in a Card Reader

A card is mounted as a removable drive on a computer after it has been inserted into the card reader and connected to a Mac or PC. Windows and Mac OS X have the required drivers for the CF card reader. For information on how to import files to Capture One, consult the Capture One online user guide available under Capture One Help in the Help Menu.

### **Warning!**

Ejecting a card or removing the battery while the Leaf Credo back is still writing (when the red LED is on) causes images that are not written to the card to be permanently lost or damaged. Do not bend or flex your CompactFlash card. Keep the card away from moisture, grit and sand. Use a CompactFlash card case as a storage container when not in use.





## 5.0 Navigating the Credo User Interface and Menu System

### Home Screen

The Credo Home screen is the first view that you see as soon as the back is switched on. This is the back's default screen and the starting point in which to navigate the menu system. Use the Home screen to configure the Leaf Credo back's setup, camera settings, ISO sensitivity and White Balance (WB) settings.

The selected ISO rating and White Balance setting are displayed on the Home screen

The bottom right of the Home screen features a Power Indicator icon that shows the remaining battery capacity or an electrical icon if the Credo is being used to shoot tethered via a USB 3.0 or FireWire 800 connection. The Power Indicator starts blinking when it runs low to warn you that the battery needs to be replaced before capturing any more images.

The bottom left of the Home screen tells you the amount of exposures left on your CompactFlash card.

Tap the top left **Home** soft button to immediately return to the Home screen regardless of where you are in the menu system.

### Image Views

Tap the image to quickly access the Full Image screen or double-tap the image to view the 100% zoom view.

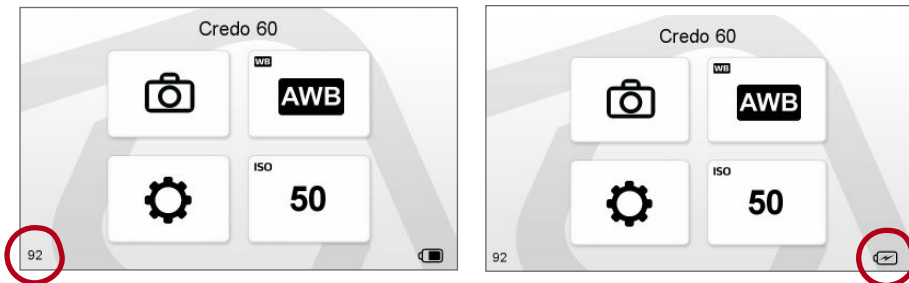



## 5.1 Soft Buttons

The Leaf Credo back is equipped with four soft buttons.

The four virtual buttons are Home, Browse, Back and Dynamic Menu options.

The **Dynamic** Menu button offers different choices depending on the function selected.



## 5.2 Touchscreen Operation

All three Credo models incorporate a newly designed 3.2 in touchscreen. The screen lets you zoom, pan and browse through images fast and it is easy to navigate between different menus and features. The Leaf Credo series backs are designed with invisible controls that are context sensitive and appear only when specific areas of the screen are touched. One example of this is the unique instant zoom function, which allows you to zoom just by using one finger. Small histograms and highlight warnings can be enlarged to full screen view by simply touching them. Wide format display allows for a full 4:3 aspect ratio image next to the histogram, highlight warning, EXIF data and touch controls.

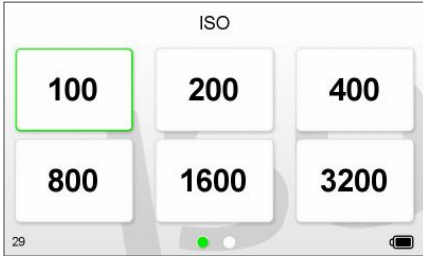
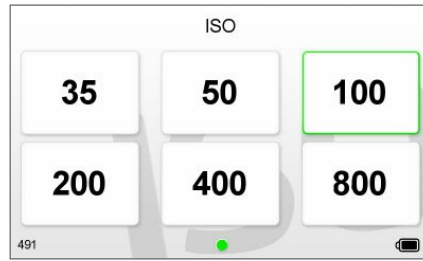

### 5.3 ISO

Tap the **ISO** icon on the Home screen. You are presented with the back's ISO spectrum. Tap the screen to select the desired setting. A green frame appears around your chosen setting and you are automatically returned to the Home screen.

The Credo 80 has a standard ISO range from 35 to 800. The Credo 40 and Credo 60 have an ISO range from 50-800, while the Credo 50 has an ISO range from 100-6400.

**Note:** Remember that the higher the ISO setting, the higher the degree of image noise. The camera system together with Capture One software deliver a powerful noise reduction performance although it is possible to still see some noise at the higher sensitivity settings.

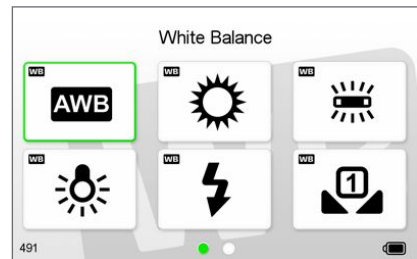

## 5.4 White Balance

Tap the **WB** icon on the Home screen. You are presented with the back's white balance settings. Scroll left and right and tap the screen to select the desired setting. A green frame appears around your chosen setting and you are automatically returned to the Home screen.

The default WB setting is Auto, which calculates a white balance based on the information in the image. Auto WB is appropriate for most applications where the subject color and lighting are consistent.

A specific light source can also be selected in the WB menu. These include Daylight, Fluorescent, Tungsten and Flash. It is easy to check the WB setting as it is displayed in the Home screen above the ISO rating.

White Balance can also be set from within Capture One when shooting tethered to a computer. Find out more on tethered operation from page 49.

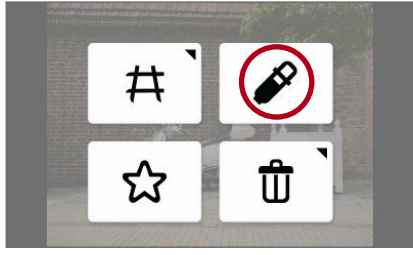

## 5.5 Custom White Balance

To create a new custom white balance, first capture a reference white balance image. (Try to use a gray card or neutral white surface). After selecting the full screen image, select the **Dynamic** menu and press the White Balance Picker icon. (Ensure that the image is in full screen view.)

Zoom in and pan to a desired part of the image and then tap on a white/gray area to create a custom WB. A crosshair icon appears on the screen. You can continue to pick a WB point elsewhere in the image until you are satisfied with the generated WB.

Tap the **WB** icon and the Save WB as: screen appears. Select **Custom 1**, **Custom 2** or **Custom 3** option. The custom white balance is set and all subsequent captures use this WB setting.

The Leaf Credo back enables you to create and store up to three custom white balance settings.



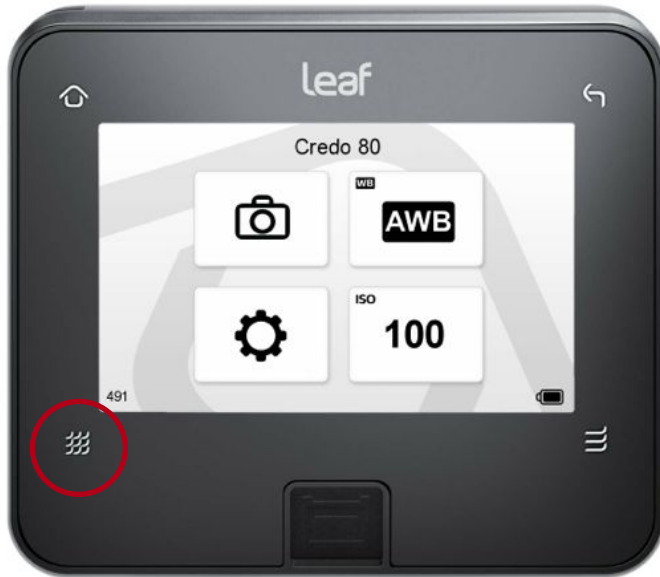

## 6.0 Browse Mode

Browse mode is used to review captured images. Its touchscreen interface makes it easy to delete, zoom, pan and browse through images quickly. Push the lower left soft button to enter this mode.

Press the Home upper left soft button to exit the Browse mode at any time.

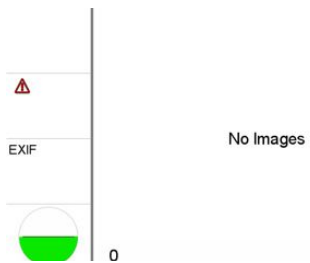

## 6.1 Browse Mode Views

Tap the **Browse** soft button to view images on the CompactFlash card. There are three Browse mode views: Full Screen, Tool View and Thumbnail View.

Full Screen displays an image in its entirety. A Zoom Slider, Dynamic menu tool and zoom level percentage automatically disappear after a few seconds of inactivity.

The default Tool View features tools that include an Exposure Histogram, Exposure Warning, File Info, Alignment tool, Remaining exposures and Battery life.

The Browse View displays images stored on a CompactFlash card in a series of 6 thumbnails.

When there are no images on the storage card, pressing the Browse soft button will bring up the Tools view with a “No Images” sign.



## 6.2 Dynamic Menu

Press the **Dynamic** Menu button in the lower corner of the back.

The Full Screen Dynamic Menu features Grid, Custom White Balance Picker, Rating and Delete options. Press and hold these icons (with a black triangle in the corner) to further configure.

The Tool View Dynamic Menu features Grid, Rating, Black and White preview and Delete options.

The Thumbnail View features a Deselect All, Select All, Rating and Delete options.

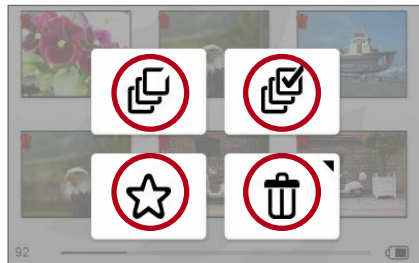
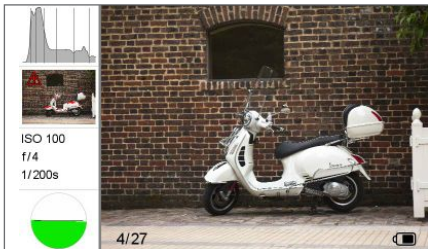



### 6.3 Info Bar

The bottom of the screen features an Info Bar that displays a Power Indicator that shows the remaining battery capacity. The Power Indicator starts blinking when it runs low to warn users that the battery needs to be replaced before capturing any more images.

Tool View displays the current image number and the number of images captured on the media. In this example it shows number 2 out of 10 images.



### 6.4 Browse Mode Navigation

Swipe the margin area just below the image to scroll through captured images in all the Browse modes. Double tap the image to zoom in at 100%, Swipe the right margin beside the image to zoom in and out, up to 400%.

Swipe your finger left or right to scroll through captured images on all Browse mode views. The selected thumbnail is highlighted with a green border.



### 6.5 Zoom

Tap the screen once in the Tool View to see a Full Screen image. The Leaf Credo back enables users to zoom into a review image by up to 400%.

Instantly zoom into a specific area at 100% by tapping the screen twice. Double tap the screen again or press the upper right Back soft button to return to the full screen view.

To zoom up to 400%, slide your finger up and down the margin of the back Slider on the right side of the screen. Use the Zoom Slider to also return to the Tool and Thumbnail Views by sliding your finger down when a full screen image is displayed.



## 6.6 Rating Images

To turn on **Rating**, tap the bottom right **Dynamic** soft button then tap the **Rating** icon. A white bar appears at the bottom of the screen when reviewing in Full Screen or in the Tool View. Tap the dot in the white bar to select a star rating from 1 to 5. Alternatively, swipe your finger along the bar to choose a star rating. Tap the blank white area on the left side of the bar to deselect a star rating to 0 (zero). Ratings are recognized in Capture One when they are imported from a memory card.

Star ratings can be seen in both the Thumbnail view and Full Screen views by tapping the **Dynamic** menu and selecting the **Star** button. To turn off Rating, return to the **Dynamic** menu and tap the **Rating** icon. The Check mark on the **Rating** icon is removed and the white bar and stars no longer appear under each image.

## 6.7 Previewing Images in Black & White

To preview images in **Black & White**, tap the bottom right **Dynamic** soft button and then tap the **BW** button. Color images saved to the CF card will now be temporarily displayed in black and white. Images are not converted permanently. To return to previewing color images, tap the bottom right **Dynamic** soft button and tap the BW button again.

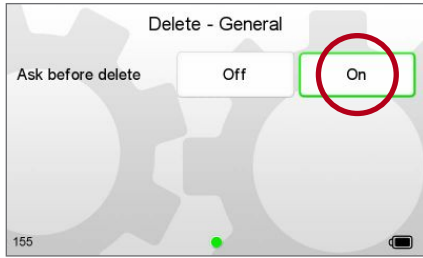
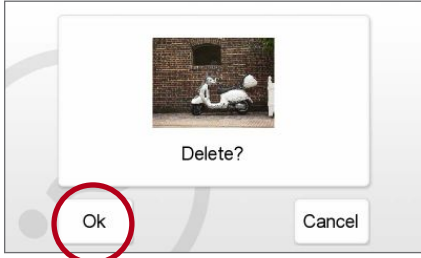

## 6.8 Deleting Images

To delete an image, tap the **Dynamic** menu soft button while in **Tool View** or **Full Screen**— a trash icon appears. Tap the **Trash** icon and the **Delete** screen appears. Tap **OK** to permanently delete the image or press **Cancel** to cancel the deletion and return to the image preview.

A long press of the Trash icon brings up a screen with an option to delete images immediately or to ask before deletion.

The **Ask before delete** option is also available when you configure the back's Settings menu.



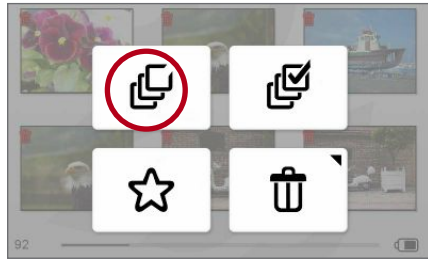
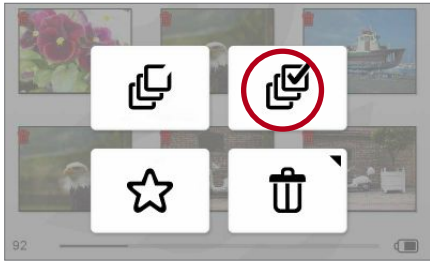
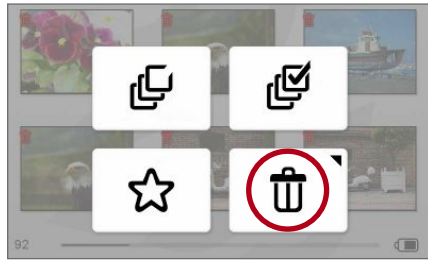

## 6.9 Deleting in Browse View

Long press a thumbnail to select it for deletion. A small red trash icon appears in the top left corner of the selected thumbnail. You can select additional images for deletion by tapping more thumbnails.

To deselect an individual image, tap the thumbnail. The small red trash icon disappears from the top left corner of the selected thumbnail. To deselect all images, tap the **Deselect All** icon in the **Dynamic** menu. All red trash icons disappear from the top left corner of the selected thumbnails.

Tap the **Trash** icon to delete the selected image or images.

To delete all images on the CF card, in the **Dynamic** menu, tap the **Select All** icon, then tap the **Trash** icon. If your setup requires a delete confirmation, a screen appears asking **Delete selected image?** Tap **OK** to delete the selected images or **Cancel** to cancel the deletion of the images.

A progress bar indicates the deletion.

Alternatively, if you want to delete all images on a card, you can also choose to format your card, which deletes all images and resets the card to a clean state.

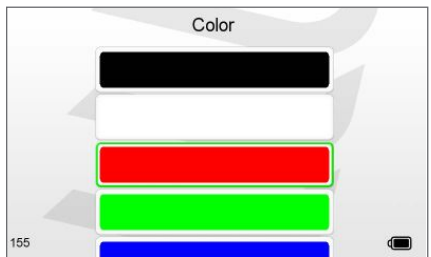
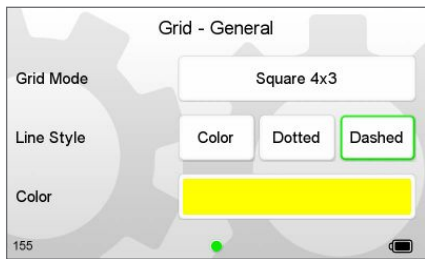
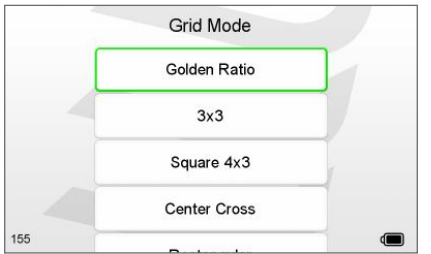
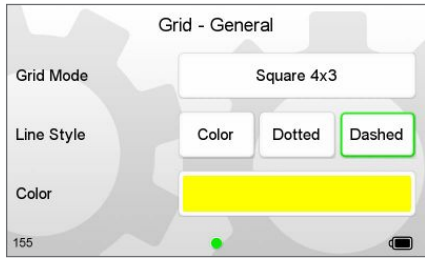
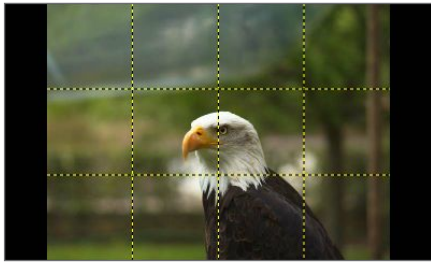
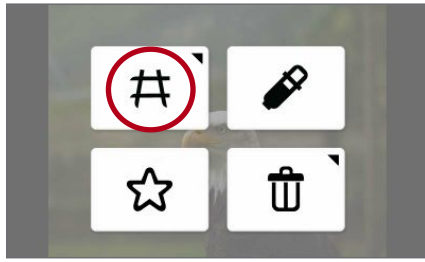

## 6.10 Grid

Select the **Dynamic** Menu and choose the (circled) icon to overlay a grid on captured images in **Full Screen** and **Tool View** modes. Tap the **Grid** icon in **Dynamic** Menu again to deactivate the **Grid**.

Long press the **Grid** icon to configure the Grid tool. It is possible to select a different Grid Mode, Line Style and Color.

The Grid Mode enables users to select one of six options that include a Golden Ratio, **3 x 3**, **Square 4 x 3**, **Center Cross**, **Rectangular** and **Fibonacci Spiral**. In **Grid Mode**, scroll down to see the full list and tap the desired option.

The **Line Style** can be changed from a solid color to a dotted or dashed line.

Change the color of the lines to one of 9 choices to help them stand out against an image.

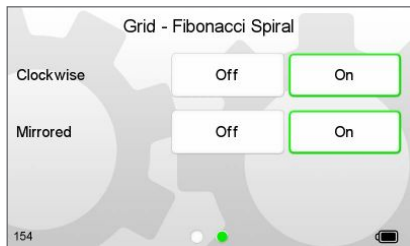
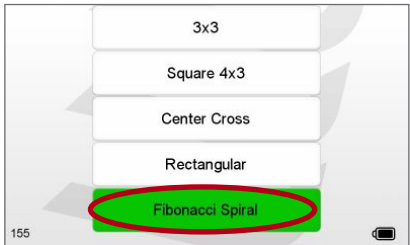
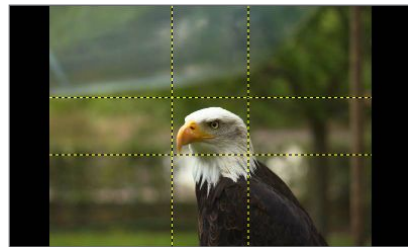
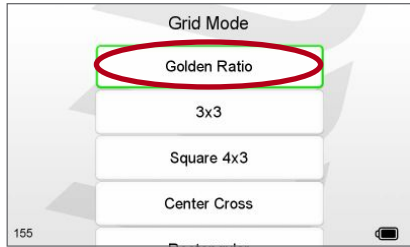
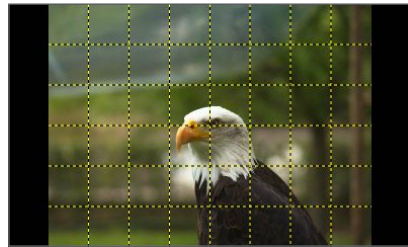
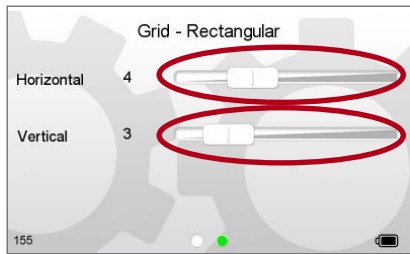

The Grid Mode provides numerous style combinations. The Rectangular option can be configured to display up to 10 horizontal and vertical lines. In this example (left) the Color has been changed to yellow and the Line Style is Dotted.

The Golden Ratio grid helps photographers compose images within classic proportions. This grid divides the screen into nine parts using two horizontal and two vertical lines. Photographers can position important elements along these lines or at the intersections.

Scroll down to see the complete list of **Grid** options.

The Fibonacci Spiral option is another classic guide that helps photographers place subject matter within the curved lines.

The Fibonacci Spiral option can also be rotated clockwise or Mirrored to help position important elements at the intersections of the lines. The Color and Line Style can also be altered to help them stand out against an image.



## 6.11 Tools

Browse mode features four Tools to aid in the capture and review of images. The Tools include Exposure Histogram, Exposure warning, File Info, and Alignment tool. Tap the **Histogram** and **Orientation** tool to make them appear full screen. Tap the **Exposure Warning** and **File Info** to make them overlay on captured images. Tap each item again to remove them from the full screen or overlay view.

### Histogram

Tap the histogram once to make the full screen version appear. The Exif information (ISO, f-stop and shutter speed) of a captured image is displayed below the histogram. The RGB channels are also displayed tap the screen again to return to the Tool view.

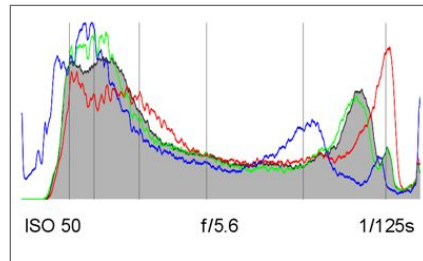

### File Info

The File Info tool displays the ISO rating, f-stop and shutter speed exposure settings. Tap the **File Info** tool to see more detailed information that includes the file name, date and time of capture, file format, exposure mode and the focal length of the lens.





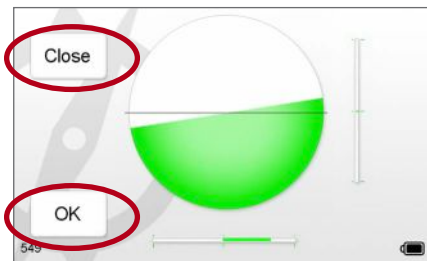
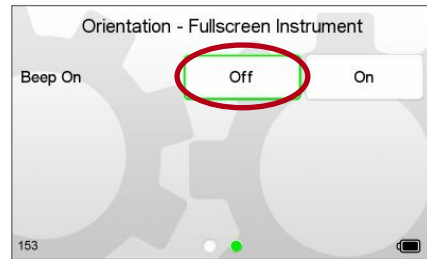
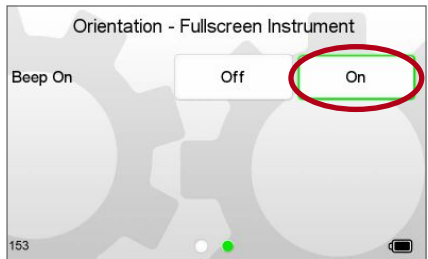
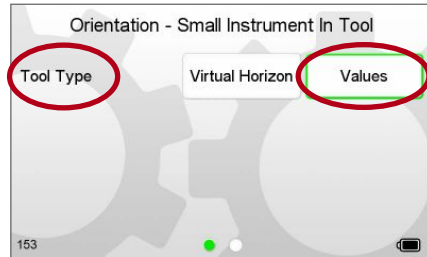
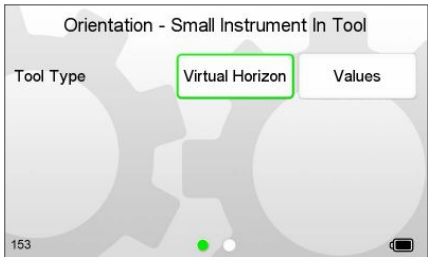
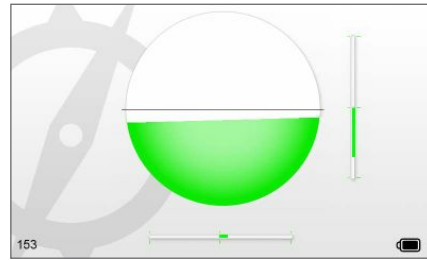

## Orientation

The Orientation tool helps keep the attached camera in a perfect horizontal or vertical position. Tap the **Orientation** tool at the bottom left of the Tool view screen to make it appear full screen. Tap the screen or tap the **Back** button to return to the Tool view.

Long tap the **Orientation** tool to alter the tool's settings. Users can choose either an illustrative **Virtual Horizon** or numeric roll and pitch **Values** by tapping the option.

Tap **On** to get an audio alert that signals that the camera is level.

## Orientation Offset Adjustment (Roll and Pitch)

The electronic Orientation tool may be calibrated for Roll and Pitch offset. It can be accessed by **pressing and holding** the Level icon in Tools view.

After levelling your camera, press the **OK** button to store your custom setting, then press **Close**. To revert to the factory setting select OFF.

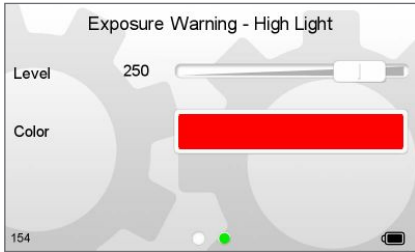
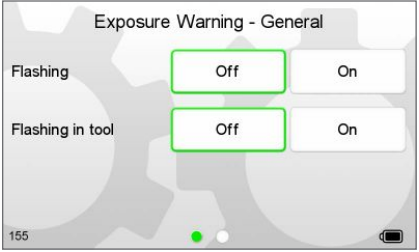

## Exposure Warning

The Exposure Warning tool highlights areas of a captured image that are overexposed. Tap the **Exposure Warning** tool to display any burned out areas of an image with a (default red) color overlay. Tap the **Exposure Warning** tool again to remove this overlay from view.

Long press the **Exposure Warning** to alter the Tool's settings. Users can choose to set the **Exposure Warning** to flash on the overlay and on the tool. The Highlight level can be changed to make it more or less sensitive. The color of the warning can also be altered to one of nine colors to help it stand out against a captured image.

The Exposure Warning overlay is seen in both full screen and zoomed in enlarged views. It flashes to indicate areas that may be overexposed. Go back to the Exposure Warning tool to deactivate the overlay.



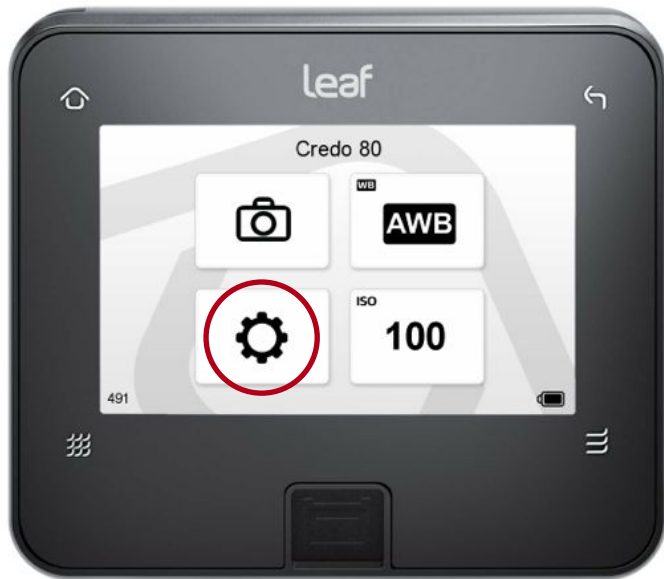

## 7.0 Settings Menu

The Settings Menu can be accessed by tapping the lower left button on the **Home** screen.

The Settings Menu can be navigated by using the touchscreen functionality and by swiping from screen to screen.

Long press the upper left Home soft button to exit the Settings Menu mode at any time.

This section explains the function of each Settings Menu option. All the options in the Settings Menu section have a default setting so that a Leaf Credo back is ready to use, straight out of the box. But the Settings Menu has numerous options that can be used to configure the setup of the Leaf Credo back to your specific needs. Some options have submenus that are indicated by three dots on the right side as shown in the Power Management menu (left).

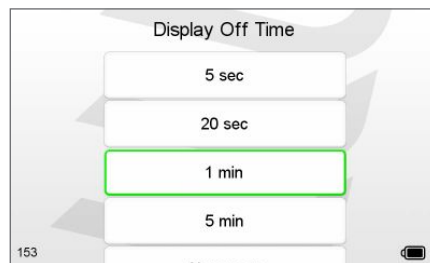
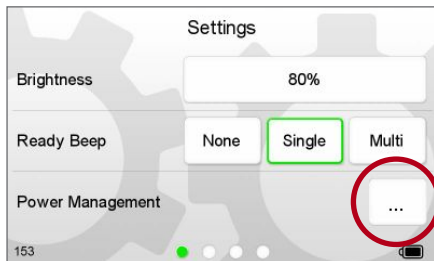

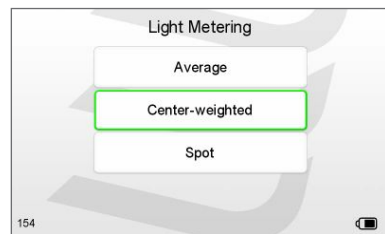
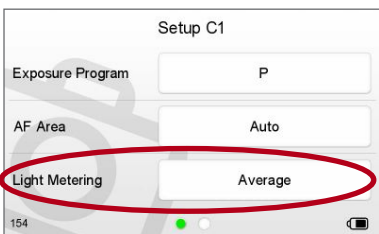
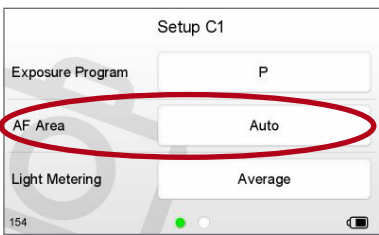
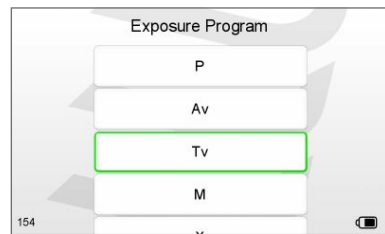
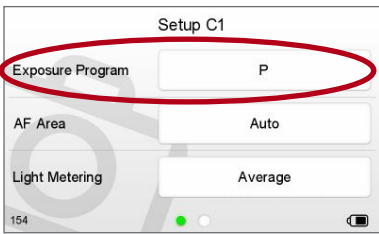
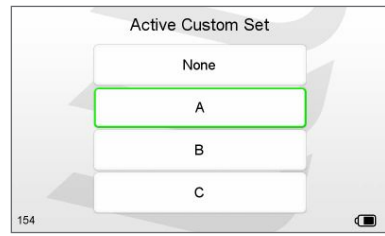
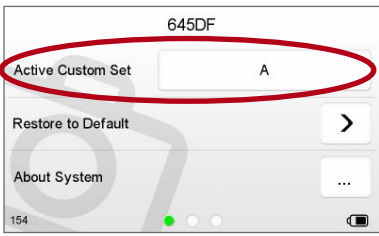
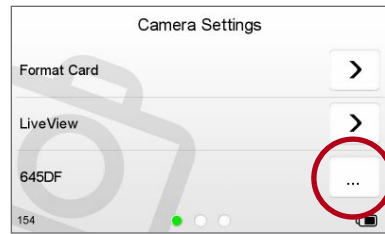

## 7.1 Camera Settings (Custom Functionality)

Pages 72 - 79 deal with the Mamiya 645DF+. Skip to the next section on page 80 if you are using your Credo on a different camera.

The Leaf Credo back enables users to set up custom camera settings for use with a Mamiya 645DF+ camera. Access the custom functionality via Home Screen > 645DF. The 645DF menu option is only present on Mamiya mount Leaf Credo backs. The 645DF+ needs to be switched on to access this menu.

Go to page 101 for more information about the 645DF+ custom functions.

### 7.1.1 Setup C1, C2 or C3

Select **Setup C1**, **C2** or **C3** and choose the desired camera exposure, AF and light meter settings as detailed from 7.3 to 7.5.

### 7.1.2 Exposure Program

Choose either the **X Mode**, **P** (Program), **Av** (Aperture Value), **Tv** (Time Value), or **M** (Manual) Exposure Program that you want to use.

Go to page 25 to find out more about the 645DF+ exposure modes.

### 7.1.3 AF Area

Select one of the four AF Area settings. The 645DF+ has three AF points that can be selected individually. The Auto mode (also referred to as Multi Area Focus) locks on to the object closest to the camera if multiple objects are located within the focus frame.

Go to page 28 to find out more about the 645DF+ AF Area modes.

### 7.1.4 Light Metering

Select one of the three Light Metering modes. The 645DF+ has Average, Center-weighted and Spot metering.

Go to page 27 to find out more on the 645DF+ Light Metering modes.

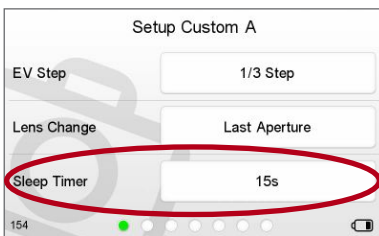
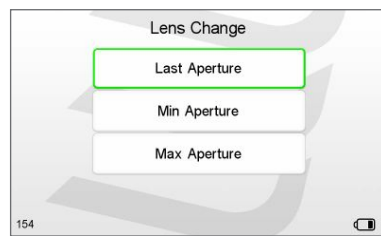
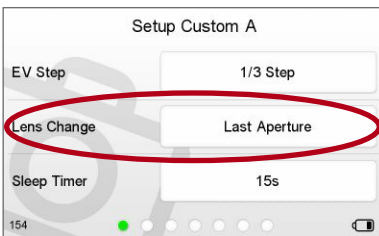
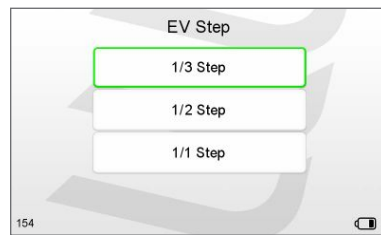
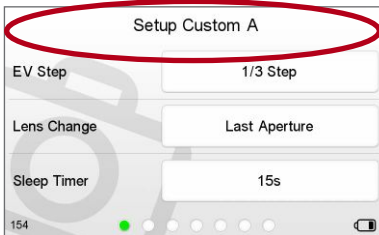
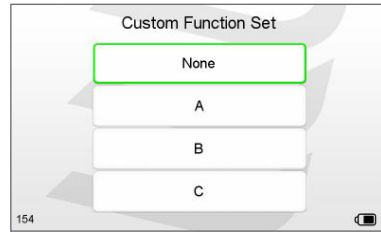
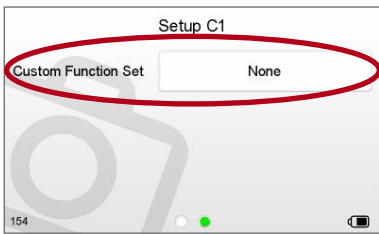

### 7.1.5 Custom Function Set

Assign the letter **A**, **B** or **C** to the chosen exposure mode settings in the **Custom Function Set** menu.

**Note:** It is possible to see the selected Exposure modes settings from the Setup C1, 2, 3 menu without having to go into the next menu option.

### 7.1.6 Setup Custom A, B or C

The Setup Custom menu enables users to adjust and select 19 camera parameters to attain a precise custom camera set-up. Select either **A**, **B** or **C**.

### 7.1.7 EV Step

Choose the size of increment adjustments concerning the shutter speed, f-number and exposure compensation value.

For example, choose 1/1 Step to adjust the aperture value in full f-stop increments as follows: f2.8, f4, 5.6, f8, f11, f16, f22 etc. Alternatively, choose 1/3 Step to change the aperture setting in smaller increments as follows: f2.8, f3.2, f3.5, f4, f4.5, f5, f5.6, f6.3, f7.1, f8, f9, f10, f11, f12, f14, f16 and so on.

### 7.1.8 Lens Change

Choose the desired aperture setting option when a lens is changed on the 645DF+ body. The Last Aperture option adjusts the new lens aperture to the same setting as the previously used lens when it was removed. The Min Aperture setting opens the aperture to its fastest setting e.g. f2.8. The Max aperture choice automatically sets the new lens to its smallest setting e.g. f22.

### 7.1.9 Sleep Timer

The Sleep Timer menu has three settings that put the camera body into sleep mode after either 15, 30 or 60 seconds of inactivity after the camera power has been switched on (via the Drive Dial). This sleep function helps prolong the camera's battery life. Half or full press the camera's shutter button to wake the camera. Select the **Disabled** option to ensure the camera remains permanently on while the Drive Dial is set to **S**, **C** or **M.UP**.

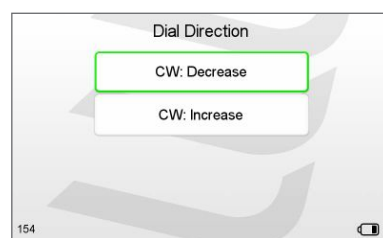
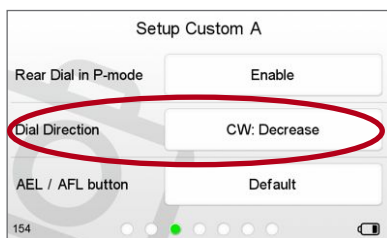
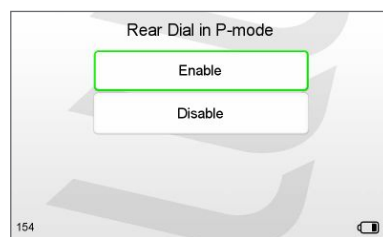
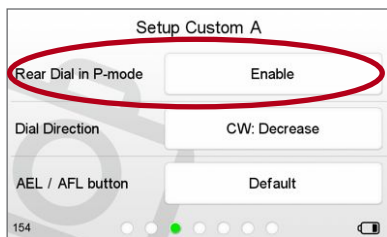
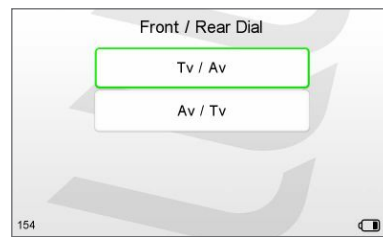
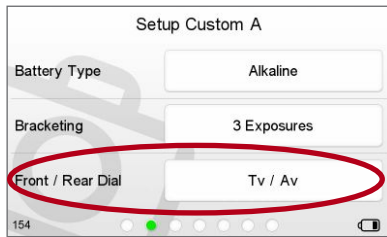
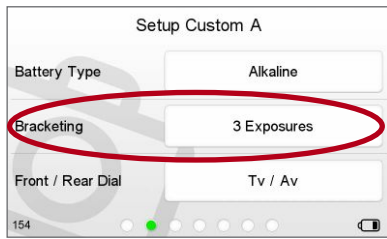
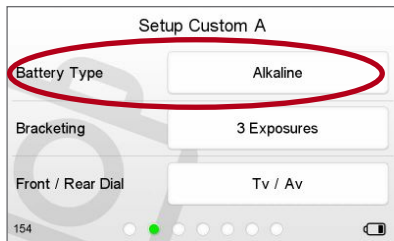

## 7.1.10 Battery Type

The Mamiya 645DF+ can be powered by three different battery types. Select the battery type that you want displayed on the external LCD panel to ensure the remaining battery charge is correctly displayed.

## 7.1.11 Bracketing

Select **3**, **5** or **7 Exposures** as the bracketing width for the auto bracketing setting. Bracketing has to be activated via the 645DF+ camera body controls.

## 7.1.12 Front/Rear Dial

Swap the function of the front and rear dials when the 645DF+ camera is used in Manual exposure mode (M). Select **Tv/Av** to assign the front dial to adjust the shutter speed (Tv = Time value) and the rear dial to the **Aperture value** (Av). The **Av/Tv** reverses the aforementioned settings.

## 7.1.13 Rear Dial in P mode

Assign which dial is used to alter the shutter and aperture value when shooting in Program (P) exposure mode. Select **Enable** to use the rear dial in P mode. Select **Disable** to activate the front dial.

Go to page 26 for more information about the Program exposure mode.

## 7.1.14 Dial Direction

Choose whether the front and rear exposure dials increase or decrease the shutter speed, f-number and exposure compensation when rotated in a clockwise (CW) direction.

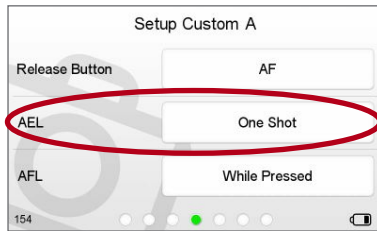
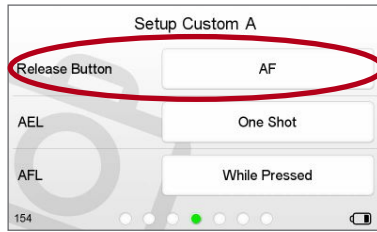
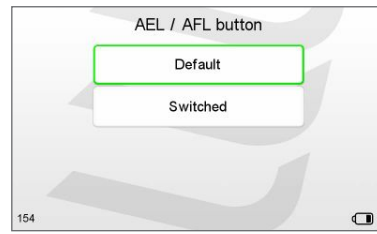
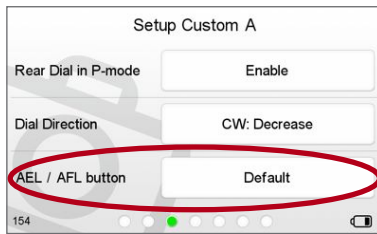

### 7.1.15 AEL/AFL button

Swap the operations of the front and rear **AEL** (Auto Exposure Lock) and **AFL** (Auto Focus Lock) buttons. Find out the location of these buttons on page 17.

### 7.1.16 Release Button

Set the AE Lock and AF operations when the shutter release button is half-pressed. Select one of the following options:

**AF:** Activate Auto Focus.

**AF & AE:** Activate Auto Focus and Auto Exposure Lock.

**Only Release:** Disable the half-press functionality.

### 7.1.17 AEL

Assign the function of the **AEL** button. The AEL button can lock AE (Auto Exposure) in one of the following ways:

**One Shot:** Press the **AEL** button once for the next single exposure to have the locked setting. This locked exposure setting is released after the shutter is triggered.

**Continuous:** Press the **AEL** button once and all subsequent captures are exposed with the locked **AEL** setting until the **AEL** button is pressed again.

**While Pressed:** The AE setting is locked while the AEL button is pressed.

**Note:** The AEL functionality is not applicable when the camera is used in Manual (M) mode.

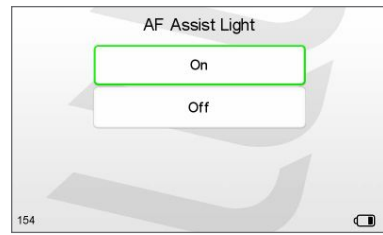
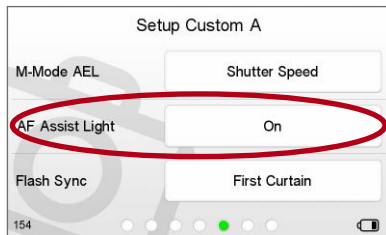
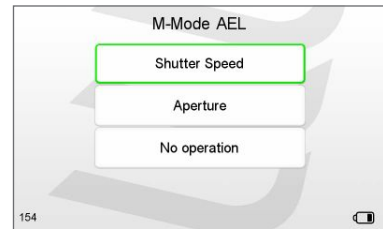
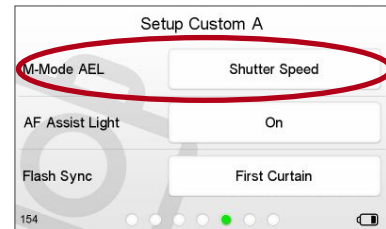
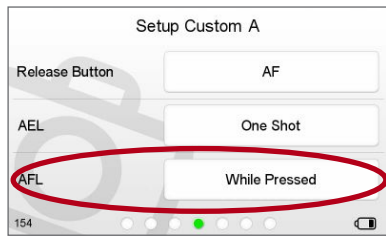

### 7.1.18 AFL

Set the function of the AF Lock button with one of the following options:

**While Pressed:** Press the AFL to lock focus once.

**AF operation:** This activates AF every time the AFL button is pressed. (It performs the same operation as half-pressing shutter button).

**Continuous:** Locks AF until the AFL button is pressed again.

### 7.1.19 M-Mode AEL

Assign the **AEL** button to automatically set an aperture or shutter value when using **M** (Manual mode). Ensure that the **AEL** button is pressed for at least 2 seconds to get an aperture or shutter value. Select one of the following options:

**Shutter Speed:** A recommended shutter speed is set when the AEL button is pressed. The aperture setting remains unchanged.

**Aperture:** A recommended f-number is set when the AEL button is pressed. The shutter speed setting remains unchanged.

**No operation:** This option disables the AEL button in Manual (M) mode.

### 7.1.20 AF Assist Light

The AF Assist Light automatically functions to help the performance of Auto Focus (AF) when shooting in low ambient lighting conditions. The AF Assist Light can be switched off from this menu. (The AF Assist Light is likely to be switched off when a flash with its own AF Assist lamp is used with the 645DF+ camera).



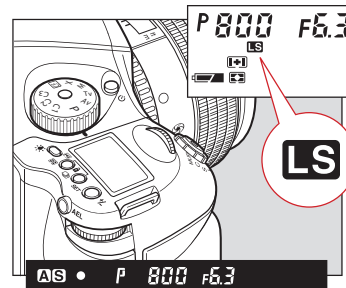
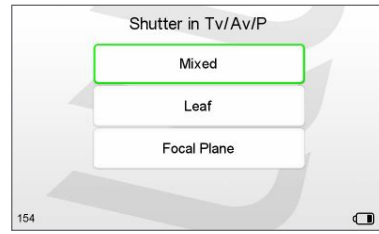
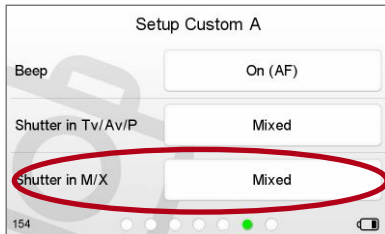
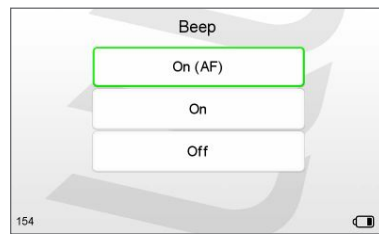
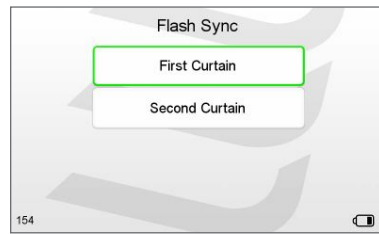
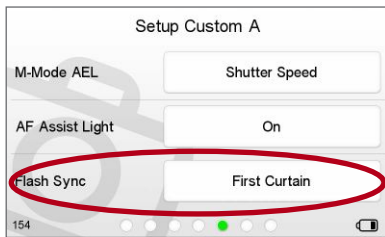

### 7.1.21 Flash Sync

The Flash Sync (synchronization) can be altered to fire at the beginning (First Curtain) or the end (Second Curtain) of an exposure. The First Curtain mode is the default setting as it is the most commonly used.

### 7.1.22 Beep

Choose when an audio beep is made from the Mamiya 645DF+ camera body. Select one of the following options:

**On (AF):** A beep is made when the Auto Focus is set.

**On:** A beep is made when the Auto Focus is set or when any button is pressed on the 645DF+ camera.

**Off:** The beep sound is disabled.

### 7.1.23 Shutter in Tv/Av/P

This menu is only applicable when a Mamiya 645DF+ camera is used in either Tv, Av or P exposure modes with a leaf shutter lens. Select one of the following options:

**Mixed:** The leaf shutter range from 1 second to 1/1600th second is selected. Shutter speeds above and below this range use the focal plane shutter. Flash synchronization is possible on all leaf shutter speeds.

**Leaf:** Shutter speeds are limited to a leaf shutter range from 1 second to 1/1600th second. Flash synchronization is possible on all shutter speeds.

**Focal Plane:** Shutter speeds range from 1 minute up to 1/4000th second. Flash synchronization is only possible from 1/60th to 1/125 second. (Depending on the flash being used).

**Note:** The LCD screen on the Mamiya 645DF+ either displays an LS (Leaf Shutter) or FS (Focal Shutter) icon to correspond to the shutter speed or custom camera setting.

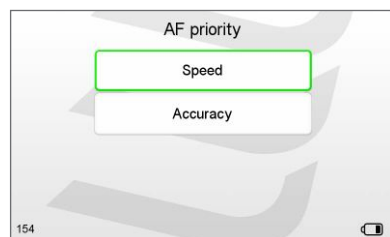
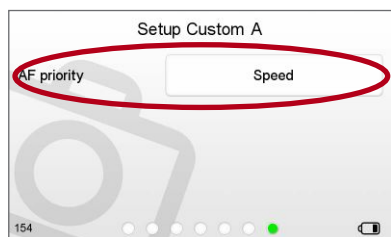
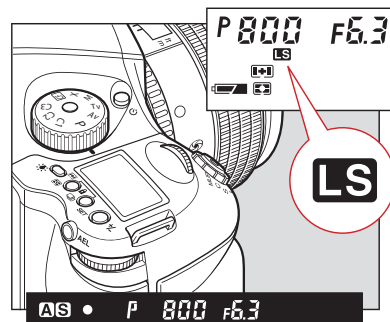
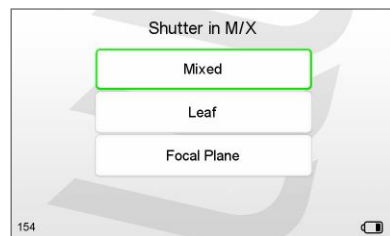

## 7.1.24 Shutter in M/X

This menu is applicable when a Mamiya 645DF+ camera is used in either M or X exposure modes with a leaf shutter lens. Using the X (flash synchronization) mode limits the shutter speed range from 1/60th second to 1/125 second irrespective of the selected (Mixed, Leaf or Focal Plane) mode. Select **Manual (M)** mode and select one of the following options:

**Mixed:** The leaf shutter range from 1 second to 1/1600th second are selected. Shutter speeds above and below that range use the focal plane shutter. Flash synchronization is possible on all leaf shutter speeds.

**Leaf:** Shutter speeds are limited to a leaf shutter range from 1 second to 1/1600th second. Flash synchronization is possible on all shutter speeds.

**Focal Plane:** Shutter speeds range from 1 minute up to 1/4000th second. Flash synchronization is only possible from 1/60th to 1/125 second. (Depending on the flash being used).

**Note:** The LCD screen on the Mamiya 645DF+ either displays an LS (Leaf Shutter) or FS (Focal Shutter) icon to correspond to the shutter speed or custom camera setting. Selecting a shutter speed outside of the leaf shutter range forces the camera to switch to the focal plane shutter.

## 7.1.25 AF priority

Select one of the following AF (Auto Focus) priority options:

**Speed:** This mode is ideal when capturing moving subject matter.

**Accuracy:** This the default setting. It is particularly recommended when the Mamiya 645DF+ is used with a lens with a long focal length.

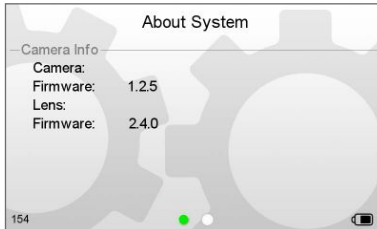
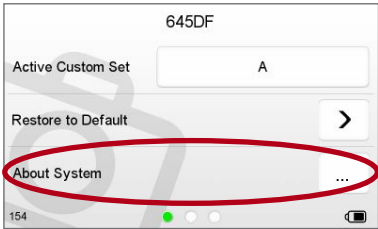
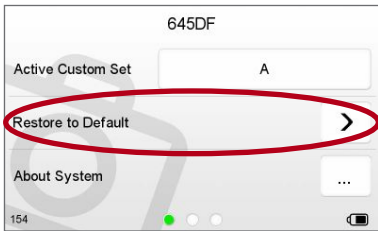
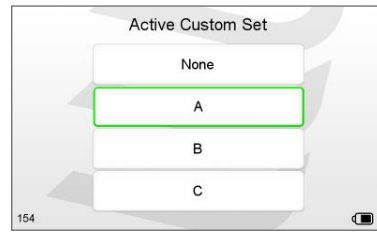

### 7.1.26 Active Custom Set

Select the desired **Custom Set** for use.

### 7.1.27 Restore to Default

Select **Restore to Default** to clear and reset all the current custom settings to the default. Warning! This cannot be undone once selected.

### 7.1.28 About System

This menu screen displays the camera and lens firmware being used. Remember to check the camera firmware number against the latest version. Go to [www.mamiyaleaf.com/firmware.asp](http://www.mamiyaleaf.com/firmware.asp) to get the latest firmware for the 645DF+ camera and Leaf Credo back.

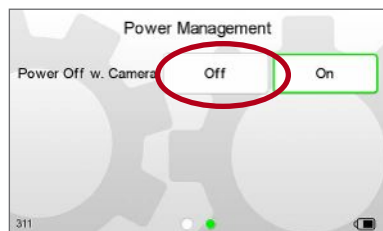
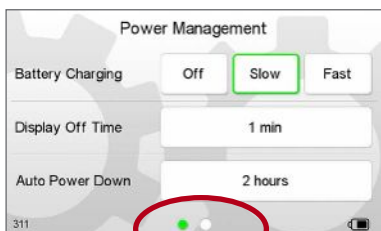
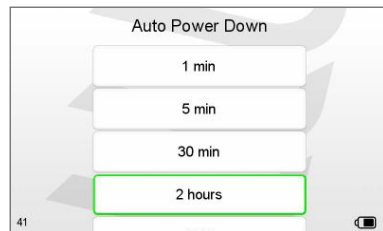
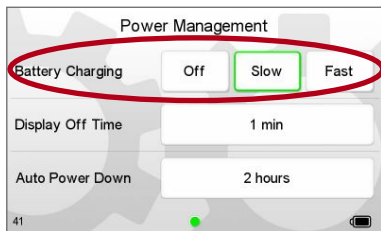
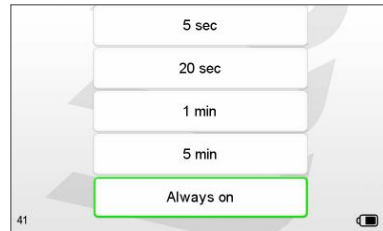
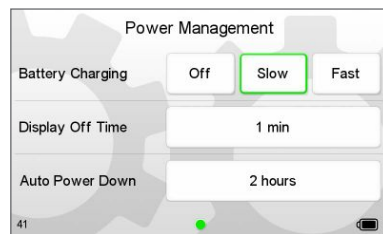

## 7.2 Power Management

The Power Management menu option has three criteria to help preserve battery life and help keep operating temperatures low when working in hot conditions.

### Display Off Time

Switch off the Credo's display screen after 5 seconds, 20 seconds, 1 minute or 5 minutes. The display can also be set to remain permanently on while the Credo is in operation with the Always On option.

### Battery Charging

The Leaf Credo back has an integrated battery charger to ensure that the battery is charged when shooting tethered via a USB or FireWire connection. This function can be switched off or set to Slow or Fast. The Slow and Off settings should be chosen to preserve the battery life of a laptop when shooting tethered.

**Note:** The battery only charges via a USB or FireWire connection when the Leaf Credo back is switched on. Only after it has been switched on, does it continue to charge when it is turned off.

### Auto Power Down

Auto Power Down determines the amount of time before the Leaf Credo back shuts down, when there is no activity. Choose 1 minute, 5 minutes, 30 minutes, 2 hours or deactivate this function by selecting **Off**.

Press the Power button to switch on and restart the Leaf Credo back after it has shut down.

### Power On and Off from Mamiya 645DF/DF+

The Credo back may also be powered on and off directly from the Mamiya 645DF/DF+ body. When the body is turned off the Credo back will power down after 10 seconds, unless it is interrupted manually on the screen or by pushing a button.

To disable this feature, scroll to the second page of the Power Management menu and tap the Off button.

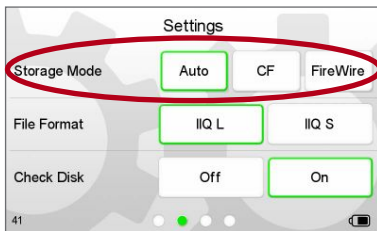
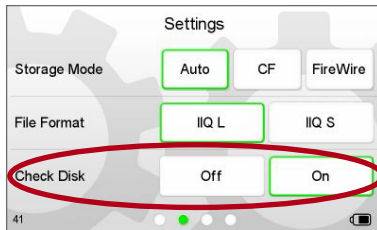
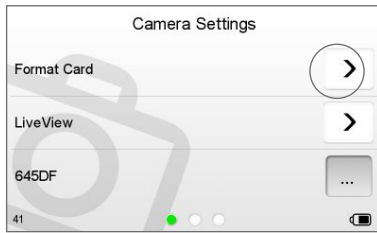

### 7.3 Format Card

Select **Format Card** to erase all data on a memory card. Memory card formatting is done in either FAT 16 or FAT 32 depending on card size. (Leaf Credo backs support CompactFlash cards formatted in both FAT 16 and FAT 32).

### 7.4 Check Disk

A disk check is performed on every memory card that is inserted into the Leaf Credo back. Mamiya Leaf recommends leaving this feature turned on, to maximize data security on memory cards. This feature can be deactivated in this menu. Read more about the Mamiya Leaf Secure Storage System on page 52 of this User Guide.

### 7.5 Storage Mode

Storage Mode allows users to configure how a Leaf Credo back stores image captures. Auto is the default storage setting and it detects and automatically stores image files to a memory card if it has been inserted in the Leaf Credo back.

If the Leaf Credo back is being used in tethered mode, it stores image files directly to the computer via the connected FireWire 800 cable. The FireWire has priority if a card is in the Leaf Credo back at the same time as it is connected by FireWire to a computer.

**Note:** The Leaf Credo back can be forced to shoot to either CompactFlash or via a FireWire 800 cable to a computer by selecting **CF** or **FireWire** respectively. An Error Message appears on the Credo screen if the Leaf Credo back is not tethered to a computer and the Credo card slot is empty.

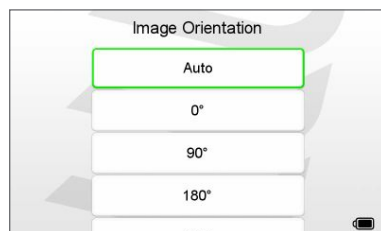
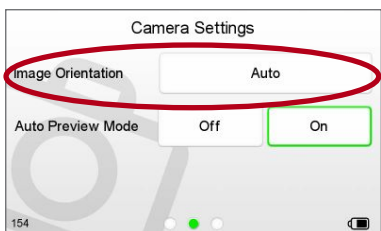
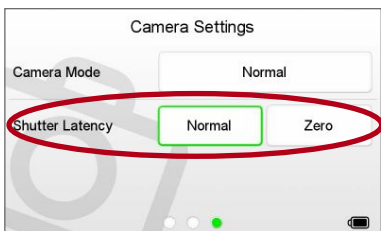
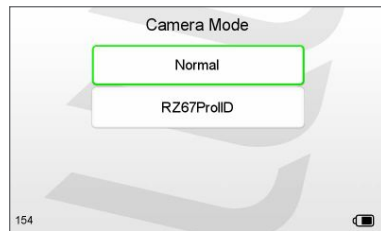
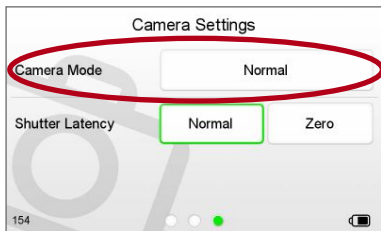
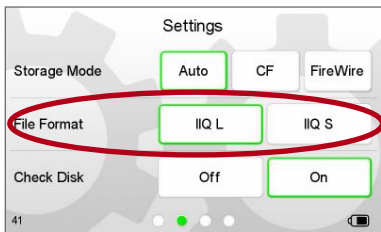

## 7.6 File Format

A Leaf Credo back can save files in two different Raw formats; IIQ L and IIQ S. IIQ stands for Intelligent Image Quality Raw. IIQ L is the default setting and it is a lossless capture format. IIQ S is a smaller file that is not a totally lossless format. An IIQ L file is approximately 1/3 the size of a processed TIFF. An IIQ S file is approximately 1/5 the size of a processed TIFF.

## 7.7 Camera Mode

There are two primary choices in the Camera Mode menu. Mamiya mount Leaf Credo backs have three choices. Select one of the following options:

**Normal:** The recommended default setting.

**RZ67ProIID:** This mode is designed to optimize the Leaf Credo back's operating performance with the Mamiya RZ67 Pro IID camera body.

## 7.8 Shutter Latency

The Credo's CCD is put to sleep to reduce power consumption when it is not in use. The Credo needs to wake up before shooting and the timing of this wake up signal is referred to as the Latency. The recommended setting is **Normal Latency** if the Credo is used with the Mamiya 645DF+. Only change to **Zero Latency** if you work on technical, large format cameras or certain manual cameras in special situations.

## 7.9 Image Orientation

The Image Orientation function sets and stores the orientation of all subsequently captured images. Select **0°**, **80°**, **180°** or **270°** to force the back to mark images as captured with that orientation. The Auto setting uses the back's built in orientation sensor to determine the orientation at the moment of capture. Changing this setting does not affect how captured images are displayed on the LCD.



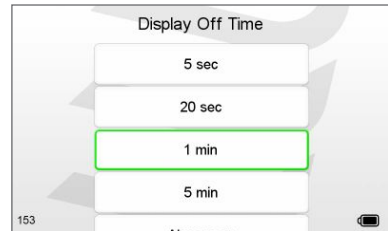
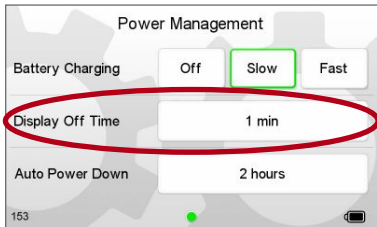
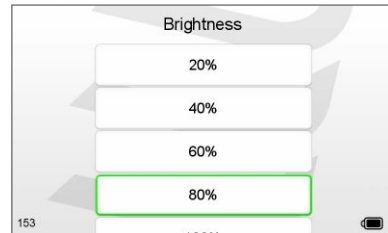
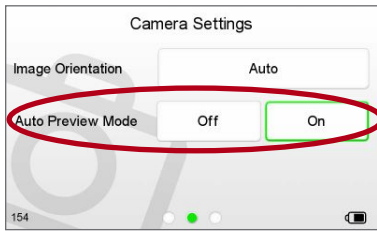

## 7.10 Auto Preview Mode

The Auto Preview option can be switched On or Off. Select **On** to revert to a Browse mode when shooting. Select **Off** to remain on the same display.

## 7.11 Display

The Display menu option has an option for Brightness, Display Off Time and Ready Beep.

### Brightness

Set the brightness of the preview LCD screen to suit ambient viewing conditions. The default setting is 80% but in bright outdoor illumination this can be increased up to 100%. Users may choose to lower the Brightness when working in low light environments, such as a photographic studio.

Altering the Brightness setting only affects the brightness of the screen. It does NOT affect the Exposure Warning, Histogram and the exposure of captures.

### Display Off Time

Switch off the Credo's screen after 5 seconds, 20 seconds, 1 minute, 5 minutes. The display can also be set to remain permanently on while the Credo is in operation with the Always On option.

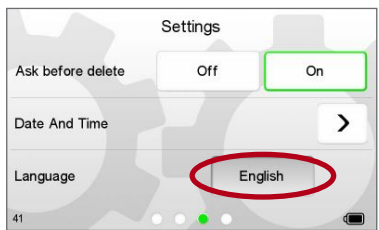
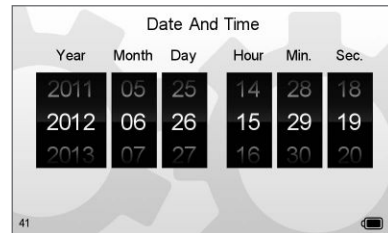
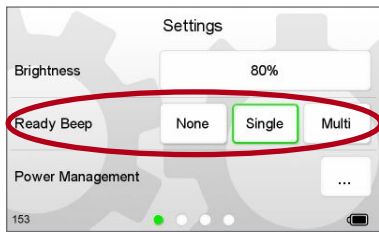

## 7.12 Ready Beep

The Leaf Credo back emits a small audio beep after every capture is taken. This Ready Beep signals that a capture has been completed, and that the Leaf Credo back is ready for the next shot.

The Ready Beep can be set to either **None**, **Single** or **Multi**. The default setting is Single. Multi is ideal for use in noisy surroundings. None deactivates the audio Ready Beep.

## 7.13 Date and Time

Set the Date and Time to your local time zone. The default Date and Time is GMT+1. Tap the screen and scroll through the numbers to attain the appropriate date and time. Tap the **Set** icon, which appears in the bottom of the screen to confirm your entry. The time and date is applied to the EXIF data in all files captured with the Leaf Credo back.

If the Leaf Credo back has been without power for a long period of time, it automatically asks you to set the date and time when it is powered up.

## 7.14 Language

It is possible to change the default **English** language setting for the Credo user interface and menu system to one of six others including **Italian, French, Japanese, Spanish, Chinese and German**.

**Note:** If a language other than English is selected and not understandable to you, select the menu option with the '**(L)**' to re-select the language (see example circled left).

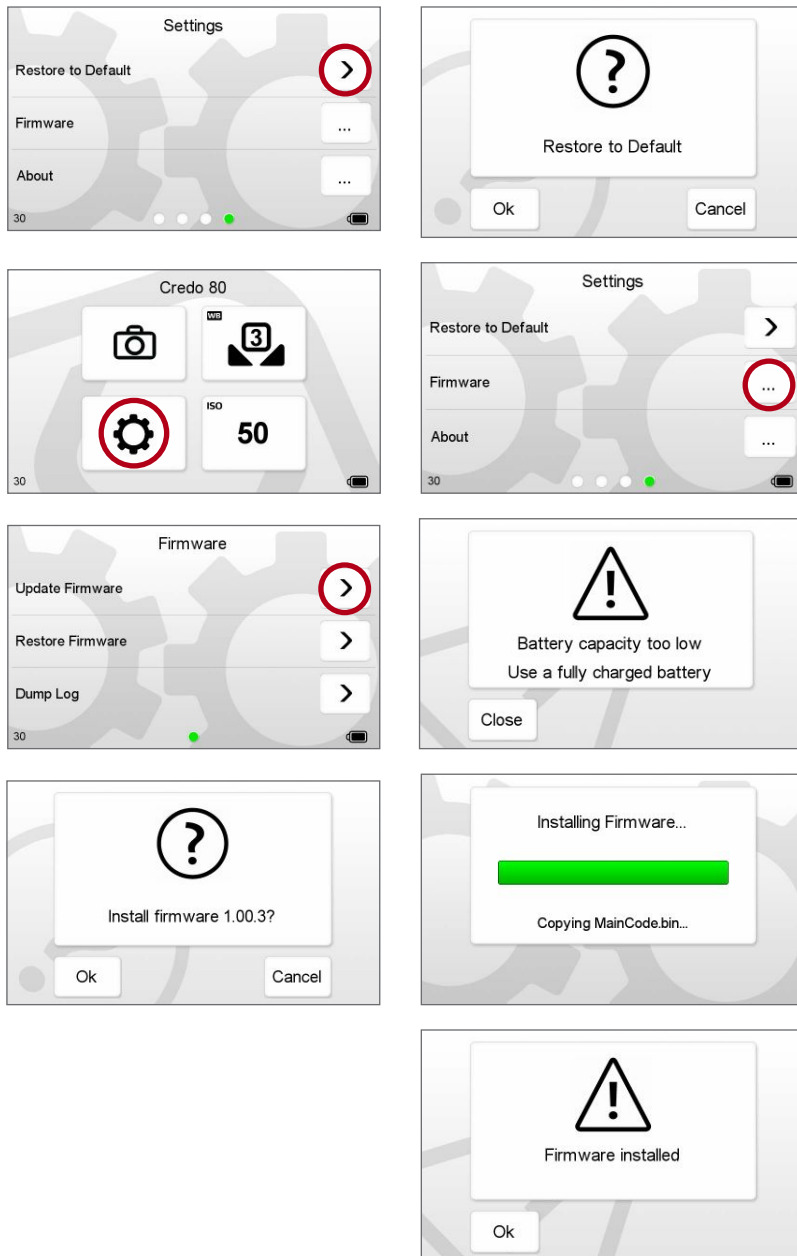

## 7.15 Restore to Default

Select **Restore to Default** to restore the Credo unit back to its default factory settings. Tap **OK** to confirm restore. Caution! All previous settings are lost.

## 7.16 Firmware

It is important to keep the Credo's firmware up-to-date to ensure you get new features and remove any bugs or errors from previous firmware versions.

1. Download the latest firmware update from [www.mamiyaleaf.com/firmware.asp](http://www.mamiyaleaf.com/firmware.asp)
2. Transfer the **firmware** (.fwr) file to a **CompactFlash** (CF) card and insert it into the Credo's CF card slot.
3. From the Home screen, select **Settings**.
4. Scroll to the fourth screen and select **Firmware > Update Firmware**. It is not possible to update the firmware unless the digital back battery is fully charged. A warning screen appears if the battery capacity is too low. Tap the **arrow** to install the firmware.
5. Ensure that the Leaf Credo back has been removed from the camera. A progress bar appears on screen during installation.
6. A confirmation screen appears once installation is complete. The Leaf Credo back automatically restarts itself.

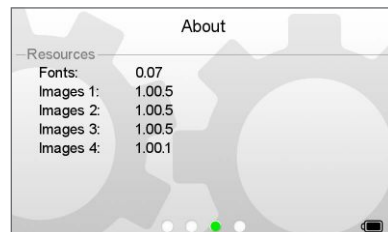
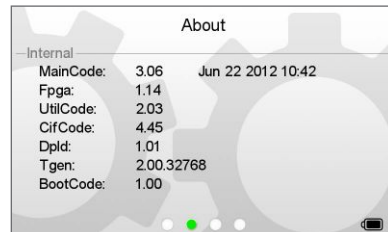
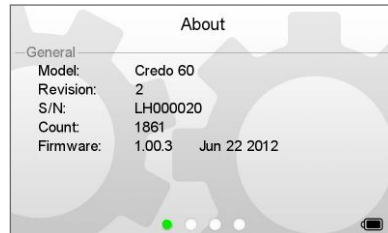
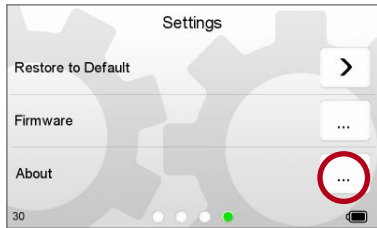

## Restore Firmware

Select **Restore Firmware** to revert to the factory firmware version. (Camera settings are not affected).

## Dump Log

Select **Dump Log** to transfer Log information to a CompactFlash card for analysis.

## 7.17 About

The About menu displays technical information about the hardware and embedded firmware in the Leaf Credo back. This is especially useful if support is needed or if you want to check if Mamiya Leaf is offering a newer firmware update. Make a note of the About menu contents (see left) before contacting your dealer or Mamiya Leaf Support.

Scroll to the additional screens to reveal internal technical data.

Scroll to the bottom of the screen to reveal Language version information.



# 9.0 Advanced 645DF+ Camera Functions

## 9.1 Exposure Compensation

In situations providing extreme high contrast, the resulting photograph may be under or overexposed. When this occurs, use the Exposure Compensation function. Exposure Compensation can also be used when you want to intentionally create overexposed or underexposed pictures.

**Note:** Creating an under or overexposed image can also be effectively achieved with the High Dynamic Range tool and Exposure tool in Capture One.

**The exposure compensation dial icon:**

1. Press the Exposure Compensation button **A** so that icon appears on the camera's top LCD. When the front or rear dial is turned counter-clockwise, the exposure is increased and when it is turned clockwise, it is decreased. The exposure compensation value can be checked on the external LCD or LCD inside the viewfinder.
2. After taking the pictures, press the Exposure Compensation button **A** again to return the exposure compensation value to 0. The exposure compensation value mark on the external LCD is cleared and the exposure compensation function is released.

**Notice:**

After taking pictures using the Exposure Compensation feature, be sure to return the exposure compensation dial to the 0 position.

The exposure compensation feature is available during AE locked operation.

The width of the exposure compensation step can be changed.

The maximum amount of the compensation can be set either at  $\pm 3$  or  $\pm 5$ .

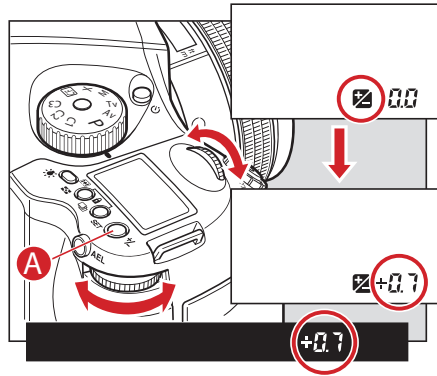

Exposure mode	Exposure compensation display	
<b>P</b>	Program AE	The set value is displayed
<b>Av</b>	Aperture Value Priority	
<b>Tv</b>	Time Value Priority	
<b>M</b>	Manual Mode	The difference between the metered value and the set Exposure value is displayed
<b>X</b>	Sync Mode	Not displayed



### Notice:

[ ] in the viewfinder LCD blinks to indicate the exposure is locked, when you continue to take the next picture in the AE lock mode.

If you turn the shutter release mode selector lever to the L (power OFF) position, or after elapse of one hour, the AE lock mode is automatically cancelled.

In the Manual M exposure mode, you cannot use the AE lock function.

When the difference between the metered value and the set value is displayed, press the **AEL** button **A** for approximately one second, and one-push shift function is activated. The camera automatically adjusts the shutter speed.

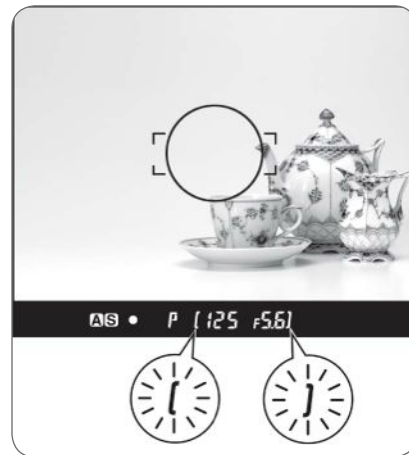
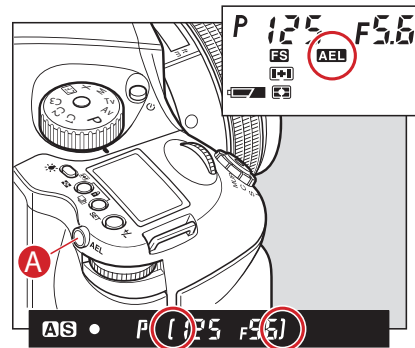

## 9.2 AE Lock

The AE lock function is useful in a number of shooting scenarios, but is particularly useful when capturing panoramic images where a consistent exposure is needed to seamlessly stitch images together in post production.

The AEL button locks the Auto-exposure value as the photo is being recomposed.

1. Turn the shutter release mode selector lever to **S** or **C**.
2. Turn the exposure mode setting dial and select **P**, **Av** or **Tv**.
3. Focus on the subject for metering exposure, and press the **AEL** button on the rear of the grip. [ ] appears on the viewfinder LCD, indicating that the exposure value is locked.
4. Slide the camera to recompose the shot, and take the picture.

When you press and hold the **AEL** button the over/under exposure value is shown to the far right in the viewfinder LCD.

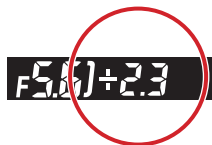
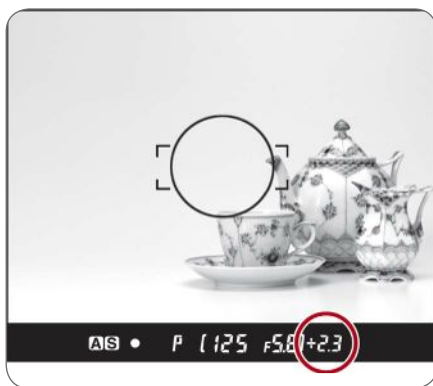
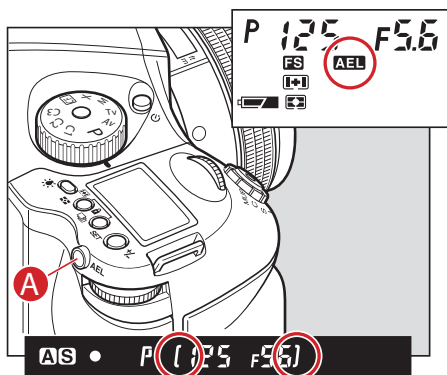

**Notice:**

The way to cancel the AE lock can be changed. **C-11 AEL function lock/unlock mode [AEL]**

Half-pressing of the shutter release button can activate the AE lock mode. **C-10 Release button [HALF]**

The assignment of the AEL button and AFL button can be swapped by using **C-09 AEL & AFL button [AEFL]**

Exposure compensation and auto-bracketing function can be used when the camera is in the AE lock mode in normal operation or with the mirror locked up.

### 9.3 Metered-Value Difference Indicator

Keep pressing the **AEL** button **A** and the difference between the metered exposure value and the exposure of the new composition is displayed on the viewfinder LCD. This function can be used to see if an object of very different brightness levels can be properly photographed.

If the difference between the set value and the metered value exceeds six EV, the viewfinder LCD blinks “- u -” for underexposure and “- o -” for overexposure.

By turning the front or rear dial in the AE lock mode, you can change the aperture and shutter speed value without changing the exposure value that is set when entered into AE lock mode.

In the **P** mode (Program AE) mode, turning either the front or rear dial shifts the program to **PH** and **PL**. When in **Av** (Aperture priority AE) or **Tv** (Shutter priority AE), turning one of the dials changes both the aperture and shutter speed values.

**Notice:**

When you want to cancel the auto-bracketing mode, turn the rear dial from **On** to **OF**.

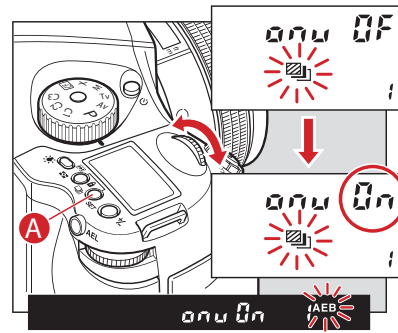

**Notice:**

After multiple turns, the mark **RP** appears in the main LCD. Repeat turning leads to a countdown being displayed on the main LCD and after taking a photo the camera returns to Auto Bracketing mode. The setting for the Auto Bracketing is stored by pressing any other button or leaving the camera for five seconds.

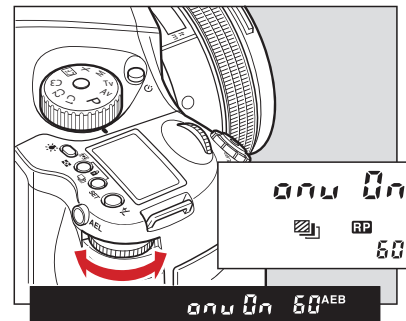
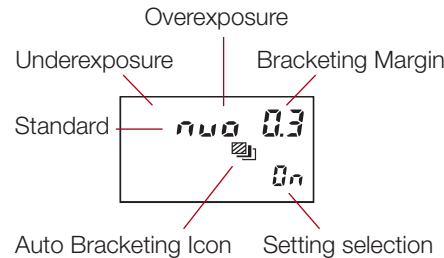

### 9.4 Auto Bracketing

Auto Bracketing can be used when it is difficult to determine your exposure compensation value. This function automatically captures different exposure variations in succession. The bracketing margin can be selected as desired for shooting in Auto Bracketing mode.

1. Turn the Shutter Release Mode Lever to the **S** or **C** position. When set at the S position, you can shoot a single frame with each full press of the Shutter Release button. In the C mode, the camera takes a series of three frames successively with one press of the shutter release button.
2. Turn on Auto Bracketing by pressing the **Auto Bracketing button** **(A)** for approximately one second. The **Auto Bracketing icon** blinks on the top LCD panel. Turn the front dial (before this indicator times out) and change **OF** on the display to **On**.
3. When the shutter button is pressed in Auto Bracketing mode, the auto bracketing mark blinks on the LCD inside the viewfinder. The bracket step width is displayed and the Auto Bracketing icon also blinks.
4. To deactivate the bracketing function, press the Auto Bracketing set button **(A)**, turn the rear dial, set auto bracketing mode to **OF**, and release. Then press the Auto Bracketing set button **(A)** or half-press the shutter button to return to the normal display mode.

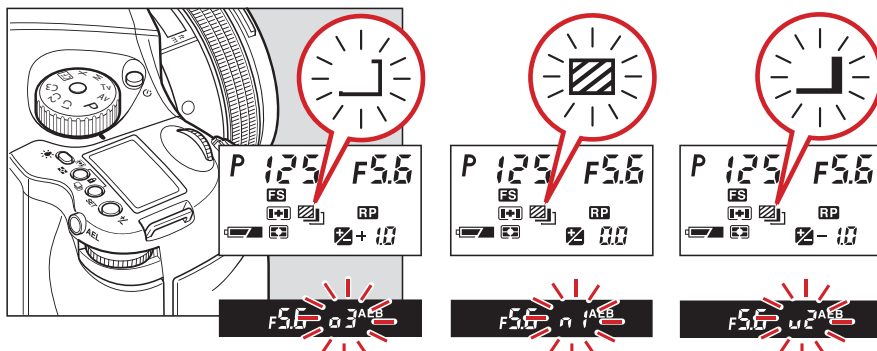

## AE Settings Under Auto Bracketing Mode

	Exposure Mode	Setting
<b>P</b>	Program AE	Shutter speed varies
<b>Av</b>	Aperture Priority AE	Shutter speed varies
<b>Tv</b>	Shutter Priority AE	Aperture varies
<b>M</b>	Manual Mode	Shutter speed varies
<b>X</b>	X-sync mode	No setting

### Notice:

When exposure compensation is initiated by pressing the exposure compensation button, shooting in Auto Bracketing mode is possible using the exposure value to which the exposure compensation value has been added.

## Single-Frame Mode (S)

Press the shutter release button for each shot. The camera meters adequate exposure value for each shot and performs Auto Bracketing. The camera stays in the Auto Bracketing mode until you cancel the Auto Bracketing mode manually.

## Continuous Mode (C)

By pressing the shutter release button once, the camera takes a series of three shots. With each full press of the shutter release button, the camera repeats auto bracketing. The standard (normal) exposure value is fixed when you take the first frame.

## Cancelling Auto Bracketing

When you want to cancel the auto bracketing mode, turn the rear dial from **On** to **OF**.

**Notice:**

Auto bracketing exposures can be made when the auto bracketing mode is set before taking photos with mirror up.

After 10 seconds, mirror up photography is cancelled

The mirror returns to the original position if the lens is removed from the camera body

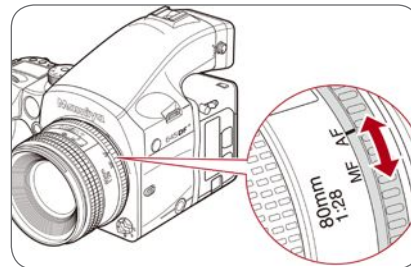
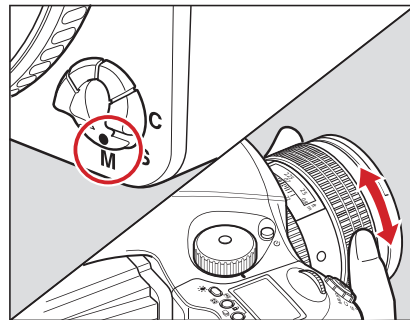
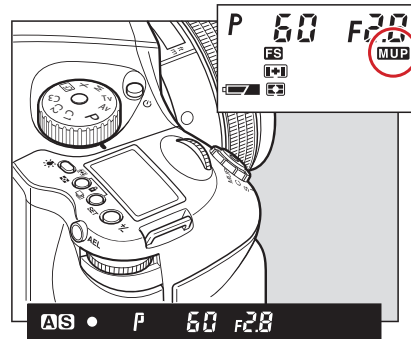
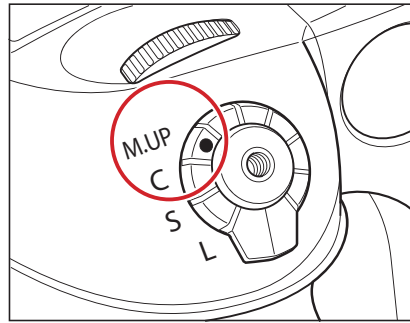
**WARNING:**

DO NOT point the lens at the sun while in Mirror Up mode. The sun's intense light can scorch and damage the shutter curtain.

## 9.5 Taking Photos with the Mirror Up

This function prevents mirror-caused vibrations which may blur an image when shutter speed is slow. An electromagnetic Cable Release RE401 (optional) is recommended for use with the mirror-up function.

1. Set the drive dial to **M.UP**.
2. Select **S** (Single focus mode) by turning the focus mode selector lever.
3. Turn the exposure dial to **P**, **Av** or **Tv** exposure mode.
4. Ensure the subject is in focus and that composition and exposure have been determined.
5. The mirror moves up when the shutter release button is fully pressed.
6. Press the shutter release button again to take pictures.

### In the Manual Mode

Follow steps 1 through 3 of the above auto focusing steps and continue with the steps below.

4. Set the focus mode selector lever to **M** (Manual focus mode).  
Turn the lens-focusing ring to focus.
5. Determine the exposure, focusing and frame structure by pressing the shutter release button halfway while looking into the viewfinder.
6. Lock the mirror up by pressing the shutter release button.
7. Press the shutter release button again to take pictures.

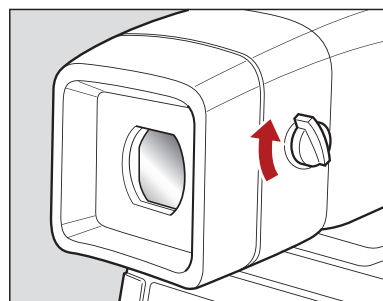
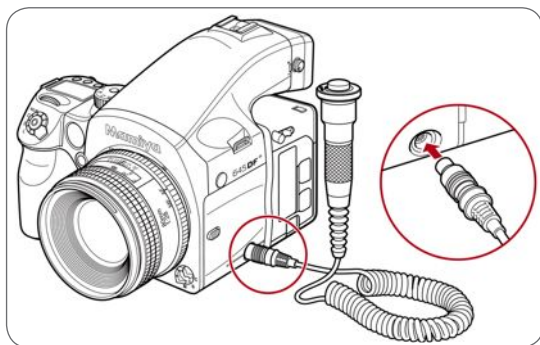
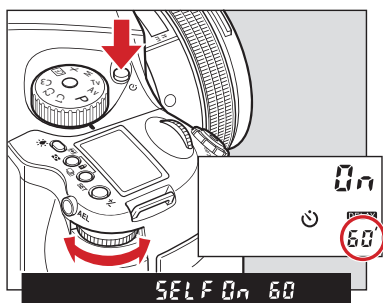
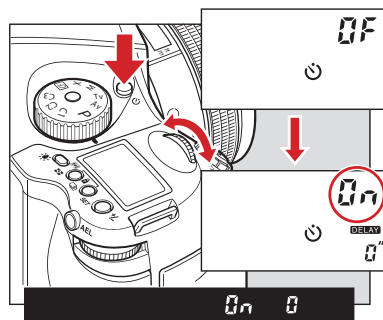

## 9.6 Mirror Up Delay

To change from the **Self-timer** to the **Mirror Up** setting, press the **shutter** button so the mirror goes into the upright position. Once the set time has expired, the shutter releases, and the mirror returns to the lower position. Separately purchased electronic cable release RE401 can be used to eliminate camera shake.

When using autofocus, the operational method is the same as steps 1 to 3 when using M.UP and autofocus.

1-3 (reference steps 1-3 in the Mirror Up Autofocus method).

4. Press the **Self-timer** button and turn the front dial to **ON**.

5. Turn the rear dial to select the time needed. 0.5 seconds to 10 seconds allows for increases by the second, 10 to 90 seconds increases by 10 seconds per turn. For 2 to 10 minutes the value increases by the minute and 10 to 60 minutes increases by 10 minutes per turn.

6. Frame the subject through the viewfinder and half press the shutter button to ensure the focus and framing is correct.

7. Press the **shutter** button and the mirror goes to the upper position, then after the exposure the shutter releases and the mirror returns to the lower position.

### Electronic Shutter Release Contact

For Mirror Up, long exposure, or slow shutter shooting, use the electromagnetic cable release RE401 or the remote control RS402. Please remove the camera's terminal cover and insert the remote plug carefully until it 'clicks' into position.

### Eyepiece Shutter

Close the eyepiece shutter when there is a strong light source behind the camera.



**Notice:**

As the camera is electronically controlled even during exposures, it is recommended to replace batteries before bulb exposure.

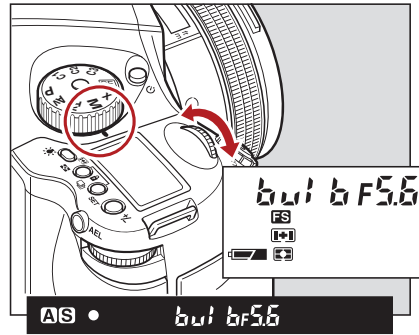

**Notice:**

Using **tInE** (Time) setting, the shutter opens and closes according to the number of times you press it.

**tInE** (Time) photography is electronically controlled so it is possible that the batteries drain quickly. If this happens, replace the batteries with new ones.

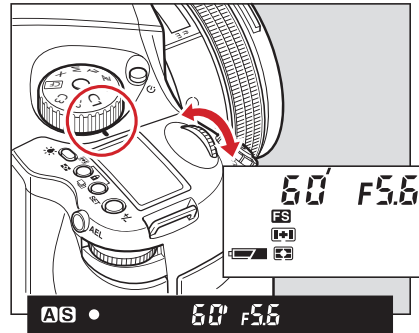

**Notice:**

When releasing the shutter, or pressing the **backlight** button **A** while the backlight is on, the backlight goes **OFF**. Choose the time of display light. **C-03 Sleptimer [HOLD]**

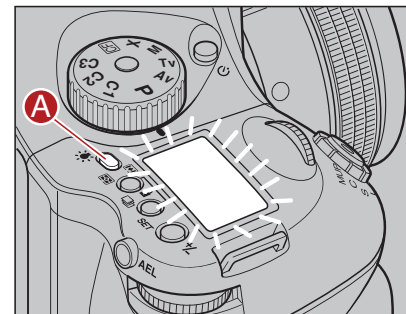

## 9.7 Bulb Mode and Long Exposure

To make an exposure longer than 30 seconds, adjust the shutter speed to **B** (Bulb). In order to prevent camera shake, use the RE401 or RS402 electromagnetic shutter release and tripod.

1. Turn the exposure mode dial to **M** (Manual mode).
2. Turn the front dial to select **bulb**, then turn the rear dial to set the aperture.
3. Determine the composition, focus and then take the picture. The shutter remains open as long as the shutter release button is pressed.

### Setting Long Exposures

When photographing under normal conditions, the shutter speed can be adjusted for longer exposures.

Turn the front dial for shooting time settings. New time settings include 1, Bulb, tInE (Time), 2, 4, 8, 15, 30, 60.

## 9.8 Camera Display Light

Press the backlight button **A**  to illuminate the top display to see it at night or in dark places.

The backlight goes on for approximately 20 seconds and turns off unless it is pressed again.

The backlight is lit for approximately another 10 seconds when operating the camera.

**Notice:**

The setting is stored after one second.

Dial lock can't be set when the exposure mode is P (Program AE).

Even while dial lock is set, the front dial or rear dial can still be used to perform the various settings. (Dial lock is temporarily released.)

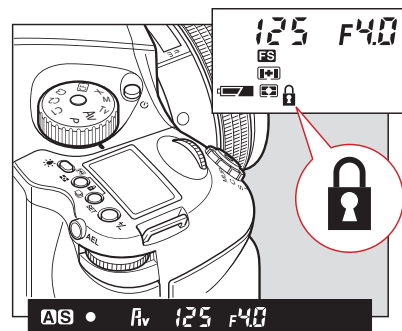
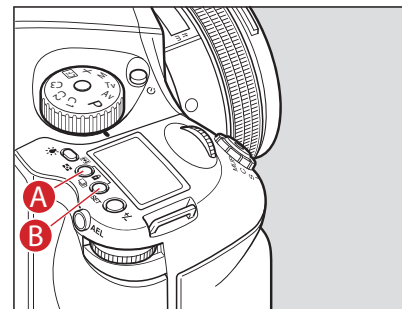
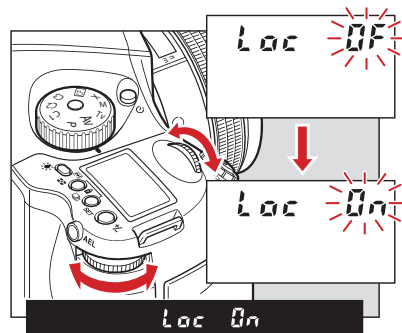

## 9.9 Front/Rear Dial Lock Mechanisms

When the Electronic Dial Lock is **On**, all currently set values in **Av** (Aperture Priority AE), **Tv** (Shutter Priority AE) and **M** (Manual mode) cannot be adjusted with the front or rear dials. This prevents accidental change of shutter speed or aperture values.

Press down the two lock buttons **A** and **B** at the same time for approximately one second, until the **On** indicator blinks.

To release the mode, hold down the same buttons until **Off** blinks.

 is displayed on the main LCD to indicate that operation of the front and rear dials is locked.

When the dial lock is ON, the shutter speed and aperture do not change even if you turn the front or rear dial.

When you activate the electronic dial lock, and then operate the electronic dial, the dial lock indicator on the main panel blinks for three seconds to show that the electronic dial lock is functioning.

**Notice:**

To release the Self-timer while it is operating, turn off the power (by setting the drive dial to L)

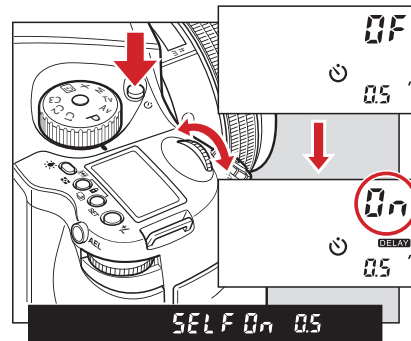
**Notice:**

In the Self-timer setting, put the drive dial to **M.UP** (mirror up) mode. If you choose to operate with mirror up and Self-timer, simply switch the drive dial to **M.UP** (mirror up) mode in the Self-timer setting.

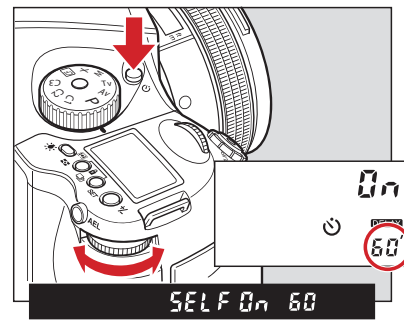

## 9.10 Self-Timer Mode

The default setting for the Self-timer mode is to release the shutter 10 seconds after the shutter release button is pressed. The Self-timer lamp flashes slowly for the first 7 seconds, and then flashes quickly for the last 3 seconds before the shutter is released. This function can be used to avoid camera shake, to take group photos or for self-portraiture.

1. Mount the camera on a tripod.
2. Switch the shutter release mode selector to the  (Self-timer mode).
3. Turn the front dial, and set the Self-timer mode to **ON**.
4. Check the view by looking through the viewfinder. Make sure that the focus is correct, press the shutter release button and the shutter is released after 10 seconds.

### Changing the Self-Timer Duration

1. Press the Self-timer button to activate this function.
2. Turn the rear dial to change the duration of the Self-timer. 0.5 seconds to 10 seconds allows for increases by the second, while 10 to 90 seconds increases by 10 seconds per turn. For 2 to 60 minutes the increases are 10 minutes per turn.

### Releasing Self-Timer mode

1. Press the Self-timer button to activate this function.
2. Turn the front dial to **OF**

**Notice:**

Repeat turning (according to the number of times) leads to a countdown appearing in the display.

After setting the interval photography, turn the drive dial to **M.UP** (mirror up mode) and you can operate in mirror up delay mode. While photographing in this setting the **AEL** is displayed on the main LCD.

When using auto bracketing, the interval function cannot be used at the same time.

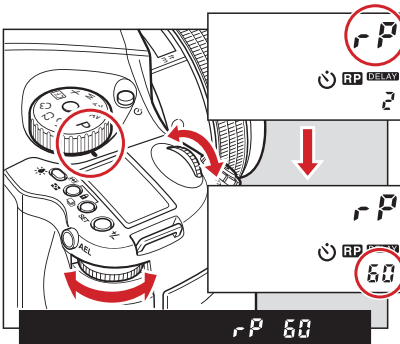
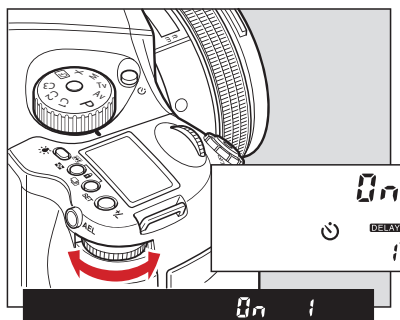
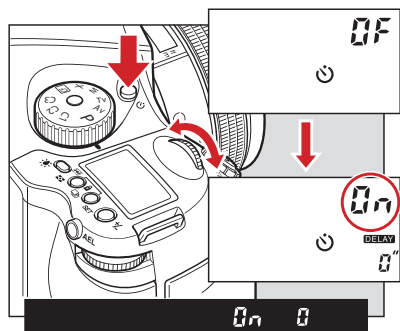

## 9.11 Interval Photography

Interval photography can be used for a variety of shooting scenarios such as capturing cloud movements or a flower coming into bloom.

1. Ensure the camera is firmly secured on a tripod.
2. Press the Self-timer button twice.
3. Turn the front dial to display interval mode as **On**.
4. Turn the rear dial to set the interval time. Settings include 0 seconds (no interval time), 1 to 10 seconds (increased by the second), 10 to 90 seconds (increased in units of 10 seconds), 2 to 10 minutes (increased by the minute) or 10 to 60 minutes (increased in units of 10 minutes per turn).
5. Turn the front dial to the repeat mode to select how many shots you want in your interval session, 1-10, or up to 60 in intervals of 10. If you want to make a motion film of your session and need more images, try shooting tethered to a computer and set the interval to **ON**. The camera does a shot until you stop the session. Remember to ensure that there is enough free hard disk space on your computer.
6. Check the focus and framing in the viewfinder then press the shutter.

### Cancelling Interval Mode

1. Press the interval mode button for interval mode.
2. Turn the front dial to **OF**

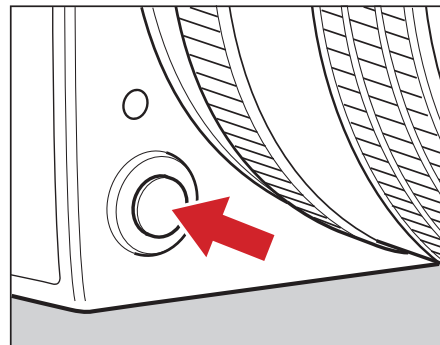
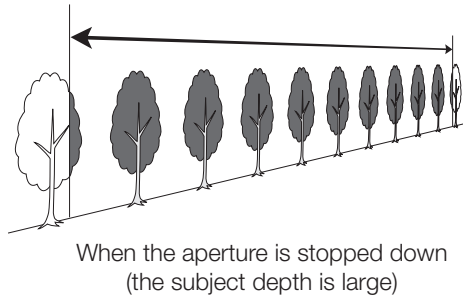
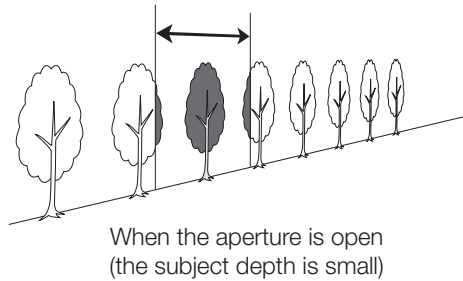
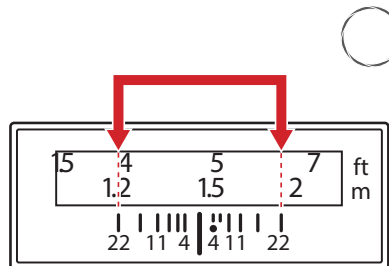

**Notice:**

While operating the preview button,  
you cannot release the shutter

## 9.12 Depth of Field

Depth of field (DOF) is defined as the zone of sharpness before and behind the plane of focus. It depends on distance to subject, focal length of lens, aperture setting and distance the lens is focused at.

In addition to visual observation via the depth of field preview button, the DOF can be determined by using the depth of field scale on each lens. The f/stop numbers appear on both the right and left side of the white index mark in the center of the scale. Simply read the figures which appear above the f/stop numbers on the distance scale of the lens.

### Depth of Field Preview Button

When the preview button is pressed in, the depth of field for the aperture set on the camera can be checked by looking through the viewfinder.

After focusing, press the preview button. The diaphragm is stopped down to the set aperture.

### Web Resources

<http://www.cambridgeincolour.com/tutorials/depth-of-field.htm>

[http://en.wikipedia.org/wiki/Depth\\_of\\_field](http://en.wikipedia.org/wiki/Depth_of_field)

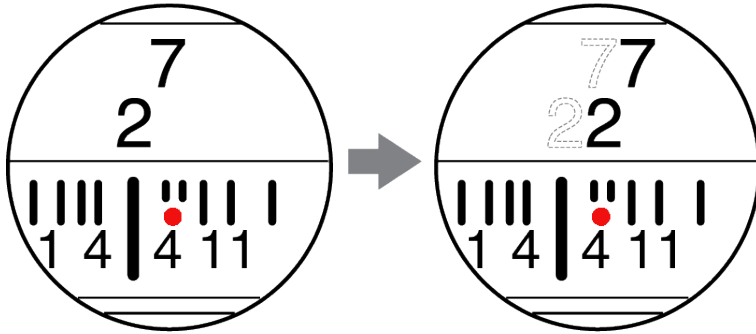
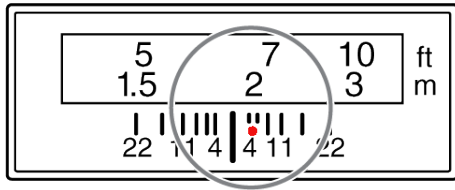

**Notice:**

You cannot take photos in AE modes when using an infrared back as the AE is based on visible light.

### 9.13 Infrared Photography

Infrared Photography is complicated when using digital backs, as the digital back is adjusted to match the viewable light perfectly.

Use a dedicated digital back for infrared photography. The Leaf Credo back needs to be adjusted to work properly for infrared photography. **DO NOT TRY THIS AT HOME!**

– All corrections in this area must be done by Mamiya Leaf to ensure precision. If you remove the protective glass or make other physical adjustments on the back the warranty is immediately voided.

**If you are considering Infrared Photography, contact your local Mamiya Leaf dealer for technical advice and pricing.**

Infrared light has a slightly different area of sharpness compared to visible light, so when the distance is set on the lens, you should always manually correct sharpness to be in front of the red dot.

Do not use your camera's light meter when photographing infrared, as the light meter is designed to measure visible light.



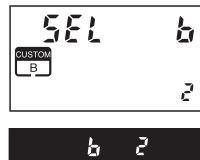
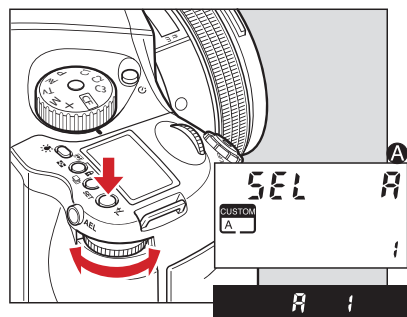
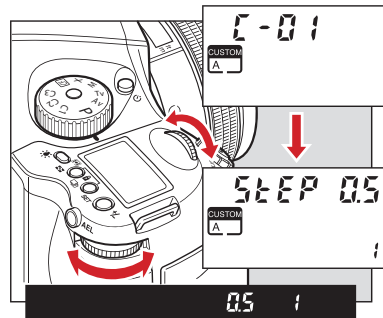
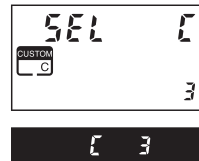
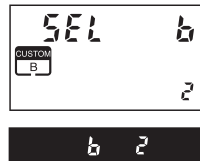
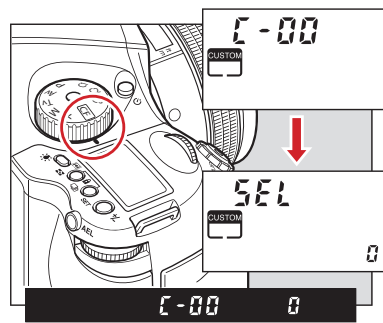
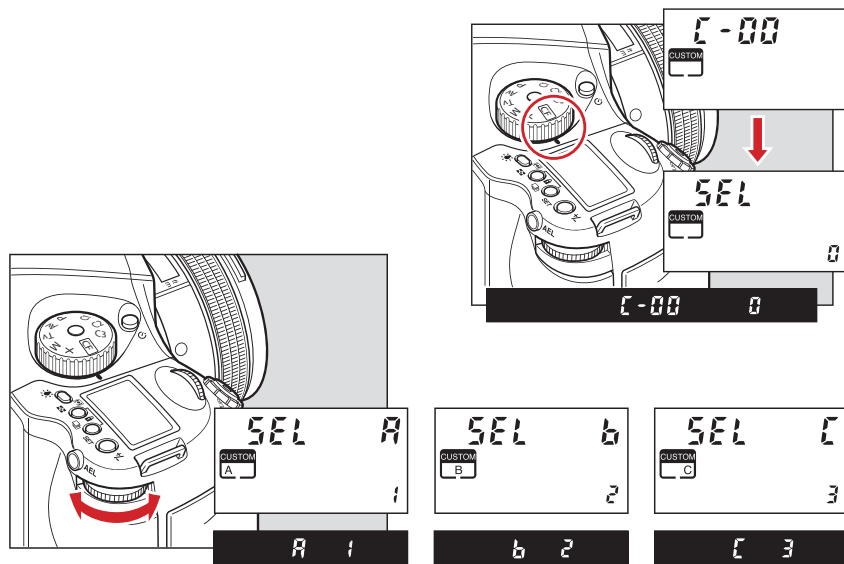

## 9.14 Custom Function

The custom functions can store three different camera set-ups. When at C-00, choose **1 (A)**, **2 (B)**, or **3 (C)** to store a specific set of user function selections for the group of custom settings from C-01 to C-20.

The C-00 is set to 0 which is the settings used for the default set.

### Setting Custom Functions

1. Turn on the power.
2. Turn the shutter release mode lever to the **S** or **C** position.
3. Turn the exposure mode dial to select **CF** (Custom Function mode).
4. Turn the rear dial to select the settings for user **A**, **B**, or **C**.
5. Turn the front dial to select the item you want to set.

### Clear all Custom Functions

Set mode dial button to **CF**, then press **+/-** button for 5 seconds; this resets ALL Custom Functions to the factory default.

### Setting Custom Functions to Default

1. By turning the exposure mode dial, **CF** (custom function mode) can be selected.
2. By turning the rear dial, user **A**, **B** or **C** can be selected.
3. Press and hold set button (for longer than 1 second) and settings for **A**, **B** or **C** can be initialized, or the settings can be returned to default.

**Note:** Custom functions for the Mamiya 645DF+ and 645DF can easily be set up and controlled via the Credo digital back.

## 9.15 Types of Custom Functions

### C-00 Custom functions profile [SEL]

- 0: None (default=0)
- 1: A
- 2: B
- 3: C

When **0** has been selected and set, none of the custom items can be set.

### C-01 EV-Steps [StEP]

Used to set the size of increments of the shutter speed, f-number and exposure compensation value.

- 0: 0.3 (1/3EV step — default setting)
- 1: 0.5 (1/2EV step)
- 2: 1.0 (1EV step)

### C-02 Lens change [IrIS]

Used to set the f-number display method for the previously used lens when the lenses have been interchanged.

- 0: Previous f-number — default setting
- 1: Maximum aperture setting
- 2: Minimum aperture setting

### C-03 Sleptimer [HOLd]

Used to set the time for sleep mode, which is established after the camera's power is turned on.

- 0: 15 seconds — default setting
- 1: 30 seconds
- 2: 60 seconds
- 3: Disabled

The batteries continuously lose power when On (no sleep mode) has been set.

### C-04 Battery Type [batt]

This function is used to set the batteries used in the camera so the remaining battery charge is displayed correctly on the external LCD.

- 0: Standard AA Alkaline batteries
- 1: AA NiMH // NiCd batteries
- 2: Li-ION rechargeable battery

### C-05 Bracketing [Stno]

Used to set bracketing range for auto bracketing setting.

- 0: 3 Exposures
- 1: 5 Exposures
- 2: 7 Exposures

### C-06 Front/Rear dial [dF]

Used to interchange the functions of the front and rear dials in the M (Manual) mode.

- 0: Front dial: Tv, rear dial: Av [OF]
- 1: Front dial: Av rear dial: Tv [On]

### C-07 Rear dial in P mode [d\_AC]

Initializing the P mode on the rear dial then changing the function to the front dial cancels out P mode function on the rear dial.

- 0: Enable
- 1: Disable

### C-08 Dial Direction [d\_dl]

This function is used to set the dial direction to increase and decrease shutter speed, f-number, and exposure compensation.

- 0: CW: Decrease [OF]
- 1: CW: Increase [On]

### C-09 AEL & AFL button [AEFL]

Used to interchange the front and rear AEL and AFL buttons.

- 0: Default setting (front: AFL, rear: AEL) [OF]
- 1: Switched (front: AEL, rear: AFL) [On]

### C-10 Release button [HALF]

This function is used to set the AE lock and AF operations when the shutter release button is half-pressed.

- 0: AF operation — default setting
- 1: AF & AE operation
- 2: Only shutter release

### **C-11 AEL function lock/unlock mode [AEL]**

Used to set the method of operating the AEL button to lock AE. At the default setting, when the AEL button is pressed, AE is locked; pressing the button again releases the AE lock. At the **1** setting (released after one shot), after AE lock is set, it is released when the shutter is triggered. At the **2** setting, AE lock is only kept while the AE lock button is being pressed.

- 0: One shot
- 1: Continuous
- 2: While pressed

### **C-12 AFL [AFL]**

Used to set the AF lock method when the AFL button is operated. AF >< Lock is activated with one press of the auto-lock button then deactivated with a second press.

- 0: While pressed (default setting)
- 1: AF operation
- 2: Continuous

### **C-13 M-mode AEL [OnEP]**

When using M (manual mode) one push function, the shutter speed or aperture value can be set automatically by pressing AEL button.

- 0: Shutter speed shift [Tv]
- 1: Aperture value shift [Av]
- 2: No [no]

### **C-14 AF assist setting [AF\_L]**

The AF auxiliary light fires automatically when the subject is too dark to perform AF, but this function can be used to prevent the AF auxiliary light from firing.

- 0: On [On]
- 1: Off [OF]

### **C-15 Flash sync. [FLSY]**

When shooting moving subjects with flash you can set the synchronization timing. This allows you to have the flash fire at the beginning of the exposure or at the end of the exposure.

- 0: First (default setting)
- 1: Second

### **C-16 Beep [bu]**

When the SET button is pressed a beep sounds.

- 0: ON (AF) (default setting)
- 1: ON
- 2: OFF

### **C-17 Shutter Tv, Av & P [Sh\_P]**

When using P, Av or Tv mode and the leaf shutter lens is attached but you prefer to use the focal plane shutter.

- 0: Mixed — default setting (Focal Plane shutter operation at < 1S)
- 1: Leaf shutter
- 2: Focal plane shutter

### **C-18 Shutter in M & X [Sh]**

When initializing the setting, use of the lens shutter (and its respective ranges) or the focal plane shutter can be chosen when the leaf shutter lens is attached.

- 0: Mixed — default setting (Focal Plane shutter operation at < 1S)
- 1: Leaf shutter
- 2: Focal plane shutter

### **C-19 AF Priority [AF\_2]**

Accuracy of auto-focusing priority (default setting) or speed priority can be decided.

- 0: Speed (aperture of f/8 is recommended when using this function)
- 1: Accuracy — default setting (recommended for lenses with long focal length)

### **C-20 AF Fine Tune**

Use this function to adjust your AF focusing point.

Use the rear dial to fine tune the focus point on the subject closer or further away from the camera.

- 50: Neutral factory calibration
- Minus: Move AF point closer
- Plus: Move AF point further away

## C-97 Support for Mamiya ZD backs

This function should **ONLY** be activated when shooting on a Mamiya ZD back.

- 0: Default setting **NO** Mamiya ZD back on the camera body
- 1: Mamiya ZD back on camera body

## C-98 Lens firmware version

The current firmware version of the lens can be checked.

## C-99 Body firmware version

The current firmware version of the body can be checked.

### Note: Clear all Custom Functions

Set mode dial button to **CF**, then press **+/-** button for 5 seconds; this resets ALL Custom Functions to the factory default.

## Liquid Crystal Display

Due to the limitations of the space and letters, words and letters on the LCD are abbreviated.

Display examples of the main LCD

<i>On</i>	→	ON
<i>Off</i>	→	OFF
<i>Err</i>	→	Error
<i>+</i>	→	+ (Plus)
<i>u</i>	→	Under
<i>o</i>	→	Over
<i>n</i>	→	Normal
<i>Loc</i>	→	Lock
<i>SELF</i>	→	Self Timer
<i>bulb</i>	→	bulb
<i>busy</i>	→	Busy
<i>db</i>	→	Digital Back
<i>LS</i>	→	Lens Shutter
<i>CAP</i>	→	Capture
<i>rP</i>	→	Repeat
<i>TIME</i>	→	Time
<i>batt</i>	→	battery

Display examples in the custom function mode

<i>SEL</i>	→	Selection
<i>STEP</i>	→	Step
<i>IRIS</i>	→	Iris
<i>HOLD</i>	→	Hold
<i>batt</i>	→	battery
<i>Shot</i>	→	Shot No.
<i>dF</i>	→	Dial function
<i>d.AC</i>	→	Dial action
<i>d.di</i>	→	Dial direction
<i>AEFL</i>	→	AE, AF lock
<i>HALF</i>	→	Half press
<i>REL</i>	→	AE lock
<i>RFL</i>	→	AF lock
<i>OnEP</i>	→	One-push exposure
<i>AF.L</i>	→	AF assist light
<i>FLASH</i>	→	Flash sync
<i>bu</i>	→	Buzzer
<i>Sh.P</i>	→	Shutter in Program
<i>Sh</i>	→	Shutter in Manual
<i>AF.2</i>	→	AF second mode

## Custom Functions Overview (most can also be set from the back as well)

No.	Item	Initial setting (0)	1	2	3
C-00	Custom Function User	Last used	User A	User B	User C
C-01	Steps of aperture, shutter speed, Exposure compensation	0.3 1/3 EV step	0.5 1/2EV step	1.0 1 EV step	
C-02	Aperture setting after lens change	Previous aperture value	Maximum aperture setting	Minimum aperture setting	
C-03	Time to sleep	15 sec	30 sec	60 sec	ON
C-04	Battery type	Alkaline	NiMH or NiCD	Lithium-Ion	
C-05	Auto Bracketing steps	3	5	7	
C-06	Front/Rear dial function exchange in manual mode	Front: Tv Rear: Av	Front:Av Rear:Tv		
C-07	Disable Rear dial in P mode	Yes	No		
C-08	Dial Function direction	No switching	Switched CCW: Increase CW: Decrease		
C-09	AEL & AFL button exchange	Front: AFL Rear: AEL	Front: AEL Rear: AFL		
C-10	Shutter half-press function	AF operation	AF operation & AE Lock	OFF (no function)	
C-11	AEL function lock/unlock mode	Continuous	One shot	While the shutter button is pressed	
C-12	AFL lock mode setting	Set with AF lock only	AF operation	Continuous	
C-13	One push function M-Mode	Shutter speed shift	Aperture value shift	Off	
C-14	AF assist beam	Fires	Does not fire		
C-15	Flash sync. timing	Front curtain	Rear curtain		
C-16	Beep	ON (AF)	ON	OFF	
C-17	Choose shutter function (P, Av or Tv mode)	Mixed (when inside the range of the leaf shutter lens)	Only leaf shutter	Only focal plane shutter	
C-18	Shutter function in Manual mode	Mixed (when inside the range of the leaf shutter lens)	Only leaf shutter	Only focal plane shutter	
C-19	AF Speed	High speed mode	High accuracy mode		
C-20	AF Fine Tune	50	Decrease	Increase	
C-97	Mamiya ZD digital back support	NO Mamiya ZD back	Mamiya ZD back		
C-98	Lens Firmware version				
C-99	Body Firmware version				

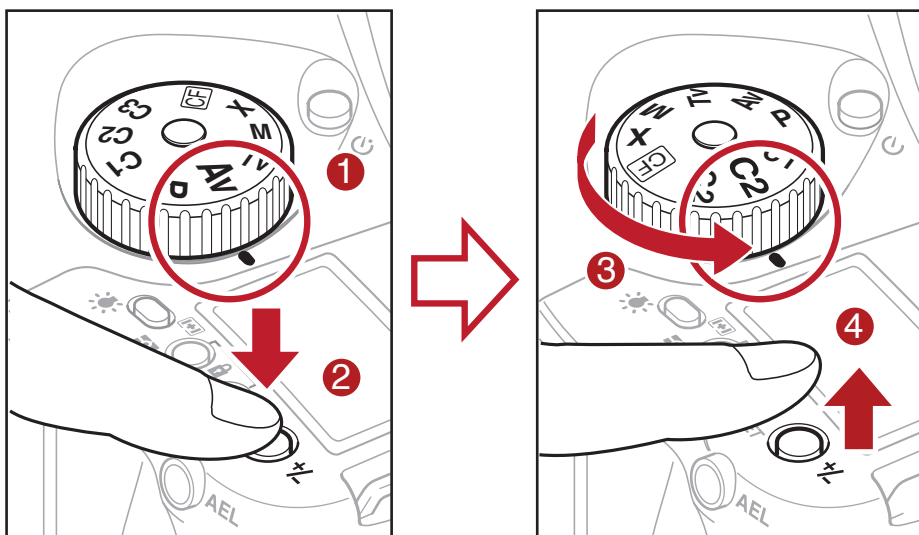

\* The illustration shows the exposure mode Av (Aperture priority AE) being recorded to C2.

**Notice:**

Even when the power is switched off, the mode recorded is still saved to C mode.

## 9.16 Custom Dial Modes C1, C2 or C3

Mode dial options C1, C2 and C3 can be used to store preferred settings.

These settings can be changed instantly to suit the photographer's needs. Users can change the settings on the camera body or via a Leaf Credo back.

Programmable settings are exposure mode, P (Program AE), Av (Aperture priority AE), Tv (Shutter speed priority AE), X (Sync mode), M (Manual mode), focus area and spot metering.

### Programming the Custom Dial Modes C1, C2 or C3 via the camera body

1. Go to the setting you wish to assign to **C1, C2 or C3**.
2. After arriving at the setting you wish to assign, hold the SET button down while turning the mode dial to **C1, C2 or C3**. When you release the SET button, the chosen setting is programmed to your selection of **C1, C2 or C3**.

**C1, C2 or C3** modes can be changed while photographing. However after taking a photo in a mode other than the modes selected in **C1, C2 or C3**, when you turn the dial back to a **C** mode setting the change is not saved.





## 9.17 Lenses and Multi-Mount

When it comes to lenses, Mamiya Leaf provides the widest range of possibilities to ensure photographers get the most creative freedom from their Mamiya camera.

This chapter looks at some possible lens systems. However, it is worth noting that there are even more applicable lenses available than presented in the upcoming pages. Users can find more information from Mamiya Leaf dealers on items such as mount-adapters, for example the Phase One Multi-Mount.

**Note:** Errors or damage caused by third party products are not covered by the warranty. Use new products with caution.

## 9.18 Function of the Phase One Lens Adapter

To mount the Phase One Multi-Mount on the Mamiya 645DF+, match the white Lens Mount Alignment Mark on the Multi-Mount with the Lens Mount Alignment Mark on the camera and turn slowly clockwise. **NEVER** use force to mount the ring. When the Phase One Multi-Mount is mounted, you can mount Carl Zeiss/Hasselblad V and Hasselblad 200 series lenses on the camera.

**Notice:**

Since the focusing screen's surfaces are soft and easily damaged, handle them carefully.

Never touch the surface with bare fingers. Should dust settle on it, merely blow away by using a blower.

If the focusing screen needs cleaning, send it to the nearest authorized Phase One service center.

Do not attempt to clean the surface of the focusing screen, as it is very delicate.

Do not touch and damage the mirror in any way.

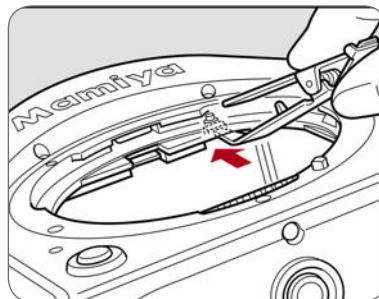
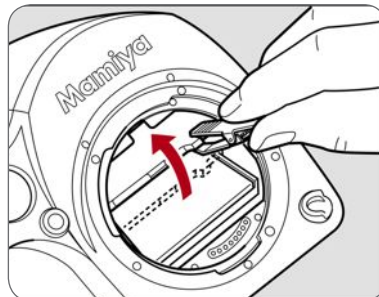
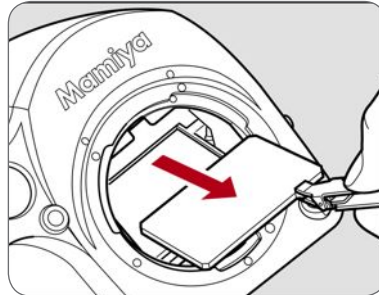
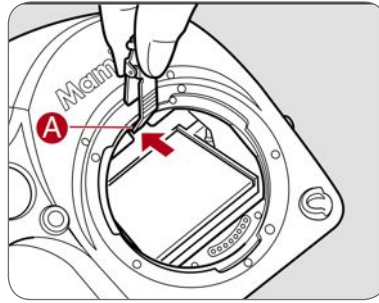

# 10.0 Maintenance

The Mamiya 645DF+ generally needs very little maintenance. But this is a professional tool and should be treated with care and caution. Always do test shots before a photographic session if the camera has not been used for a long period of time.

A frequently used product should be inspected periodically at the nearest official Mamiya Leaf repair center. Do NOT try to repair any camera, lens or back errors or malfunctions – consult your local dealer.

## 10.1 Changing the Focusing Screen

1. Remove the lens.
2. Pull the Focusing Screen Release lever **A** forward, as illustrated, with tweezers to ease the focusing screen down.
3. Remove the focusing screen from the focusing screen frame by grasping the tab on the edge of the screen with tweezers as illustrated.
4. When installing the screen, pinch the tab of the screen with tweezers, and place the screen on the screen frame.
5. Push the screen frame up using the tweezers until hearing a clicking sound. The screen is now properly installed. Never press down on other parts as this affects the focus function.

**Notice:**

Make sure to re-install the empty battery case into the body.

The empty battery cassette must be inserted into the body.

The batteries may generate heat if the external battery case is connected to the body while the batteries are loaded on the body.

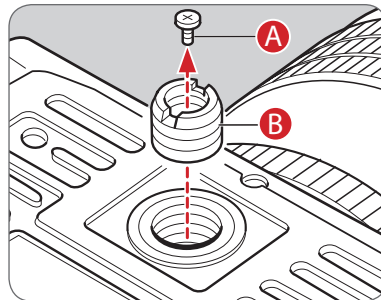
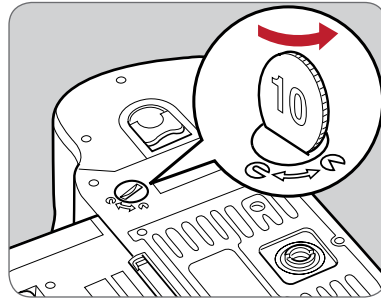
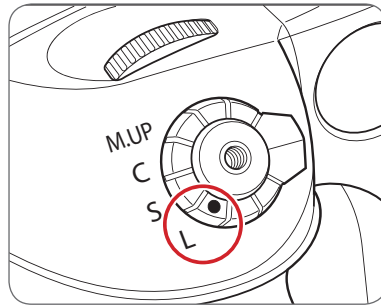

## 10.2 Battery Socket

Never leave batteries in the socket if the camera or back is not going to be used for long periods of time.

Keep contacts clean and dry at all times.

### External Battery Socket

Use an external battery case PE401 when using the camera in cold environments, where the battery capacity may drop.

1. Turn the shutter release mode selector lever to the **L** position (power off).
2. Use a coin or similar object to turn and remove the external battery socket cap.
3. Remove the battery case from the camera body
4. Connect the external battery case to the body.
5. Connect the plug of the external battery case in which the batteries are installed, to the external battery socket.
6. Reinstall the original battery case, from which the batteries were removed, in the body. Turn the battery case lock to lock it in the body.

## 10.3 Tripod/Electronic Shutter Release Contact







Keep all contacts clean and dry at all time.

When using a tripod with 3/8 in screw (instead of 1/4 in screw), remove the small screw **A** from the tripod screw hole on the bottom of the body using a Phillips screwdriver, then use a coin to remove the tripod screw adapter bushing **B**.

The Electronic Shutter Release is found both on the camera body and on the back. When needed, it is recommended to use the shutter release on the back. Keep both contacts dry and clean.

## 10.4 Camera Display Error-Notification

When Any of These Displays Appear...

LCD Display			Causes and remedies	
Main LCD Panel	Viewfinder LCD readouts	Magazine LCD	Problems	Remedies
			<p>* If the camera cannot focus in the <b>AF S</b> (Single) mode, you cannot release the shutter.</p> <p>* When an M645 lens is mounted and the aperture is less than f/5.6, this indicator appears.</p>	<p>Try to adjust focus again, or change to the focus lock mode or manual focus mode.</p> <p>Make the lens aperture faster than f/5.6.</p>
batt			<p>* This indicator appears when the battery capacity is low.</p>	<p>Replace with new batteries.</p>
-no-db			<p>* The shutter does not operate when the digital back is not attached to the camera body. If you try to press the shutter, this indicator appears.</p>	<p>Attach the digital back onto the camera body.</p>
			<p>* This symbol appears when setting the custom functions but you have not selected user A, B, or C.</p>	<p>Select a user before changing the custom function settings.</p>
	- U - - O -		<p>* While in manual exposure mode, and when the difference between the set value and metered value exceeds, this indicator appears.</p>	<p>Change the aperture or shutter speed.</p>
F- -			<p>* Appears when a lens is not mounted.</p> <p>* When an M645 lens is mounted.</p>	<p>Mount a lens on the camera body.</p>
Err-01 Err-02 Err-03 Err-04 Err-05 Err-06 Err-07			<p>When <b>Err</b> appears, an abnormality has been detected in the course of taking photos.</p>	<p>Replace with new batteries and press the shutter release button. If the <b>Err</b> indicator still appears, contact our office or service center.</p>

\* The camera caution mark  blinks if the camera body detects an abnormality.



## 10.5 Lens Maintenance

Never touch the inner optics of the lens with your fingers. Keep the inner optics perfectly clean with air, a lens brush or the dry cloth delivered with the lens.

Do not touch the contacts. Keep the contacts clean with either a dry cloth or by using a fiberglass brush. Do not use any other tools on the lens.

The lens is not waterproof. It should be immediately dried with a cloth if it becomes wet. If it is exposed to salt, moisten a cloth, wring it and carefully clean.

## 10.6 Back Maintenance

### **Cleaning the IR Filter**

The Leaf Credo back must have the protection plate fitted when it is not attached to a camera. Dust may accumulate on the IR filter, which degrades the image quality if not removed. Follow the directions found at <http://www.mamiyaleaf.com/cleaning.asp>.

## 10.7 IR Filter on the CCD

The IR filter (Infrared reduction filter) is permanently mounted on top of the CCD. The filter may not be removed for several reasons:

- The focusing of the Leaf Credo back camera back can be altered.
- It is only possible to remount the filter without dust getting in between the filter and the CCD if you have access to special clean room facilities.
- The Mamiya Leaf Product Warranty is terminated.

## 10.8 Mamiya 645DF+ Camera Body Specifications

- Open platform for maximum choice and compatibility
- Durable, proven platform for secure operation
- Ergonomic handling and ease of use
- Use Mamiya digital lenses, Mamiya AF/AFD lenses or Hasselblad V lenses
- Exposures from 1/4000s to 60 minutes
- Flash synchronization up to 1/1600 sec

Shutter speed from 1/4000s to 60 minutes, extremely high flash synchronization up to 1/1600 second to stop action with fast shutter speed or flash.

The mirror and viewfinder of the Mamiya 645DF+ camera are almost three times larger than those of 35mm cameras, providing much greater control of focus and composition.

While hosting a complete list of features and custom functions, the Mamiya 645DF+ camera is extremely easy to use. All settings important to the exposure are easily controlled by manual dials and soft buttons.



<b>Camera type</b>	Modular 645 AF SLR body
<b>Lenses</b>	Mamiya Digital focal plane lenses, Schneider-Kreuznach designed leaf shutter lenses and Mamiya 645 AFD lenses Compatible with Hasselblad V lenses
<b>Backs</b>	Open platform back mount
<b>Auto focus</b>	TTL phase-difference AF Focus confirmation in manual mode Infrared AF assists for unfailing focus Auto focus lock for swift AF/M shift
<b>Shutter</b>	1/4000s to 60 minutes Up to 2 fps Shutter speed bracketing
<b>Flash</b>	Focal plane shutter: Up to 1/125s Leaf shutter lenses: Up to 1/1600s' 1st and 2nd curtain flash synchronization X sync terminal and support for TTL flash
<b>Light Metering</b>	TTL metering (average, spot and auto) Programmable AEL button Exposure compensation: +/- 5EV
<b>Mirror-Up</b>	Electronically activated by switch on grip
<b>Viewfinder</b>	Fixed prism viewfinder Exchangeable diopter from -5 to +3 LCD panel with full exposure information
<b>Focusing Screen</b>	Interchangeable focus screens Laser engraved mask for digital back Matte, Grid, Checker, Microprism
<b>Self-Timer</b>	Self-timer from 2 to 60 sec
<b>Remote</b>	Screw-in cable release on shutter button Terminal for electronic triggering devices
<b>Stop Down Preview</b>	Stop down button on front of camera
<b>Tripod Socket</b>	1/4 in and 3/8 in included
<b>Power Requirements</b>	6 AA batteries (standard or rechargeable) Rechargeable Li-Ion battery pack External battery pack – 6 AA batteries External AC adapter
<b>User configuration</b>	3 Custom dial modes for capture settings 36 custom settings Customizable dials and buttons
<b>Size</b>	6 x 5 x 7.2 in / 153 x 128 x 184 mm (W x H x D)
<b>Weight</b>	35 oz./1030 g. without batteries

Content is subject to change without notice.



## 10.9 Mamiya 645DF+ Housing Specification

<b>Camera type</b>	6 x 4.5 cm format, electronically controlled focal plane shutter, TTL multiple mode AE, AF single lens reflex.
<b>Actual image size</b>	56 x 41.5 mm.
<b>Lens mount</b>	Mamiya 645 AF Mount, compatible with M645 Mount (manual focus confirmation, focus aid, stopped-down exposure metering).
<b>Viewfinder</b>	Fixed prism viewfinder magnification x0.71; built-in diopter adjustment (-2.5 to +0.5, optional diopter correction lenses provide adjustment ranges of -5 to -2 diopter and 0 to +3 diopter); built-in eye-piece shutter.
<b>Focusing screen</b>	Interchangeable, Matte (standard), Checker, and Microprism Type C for Non-AF M645 lenses.
<b>Field of view</b>	94%* of actual image.
<b>Viewfinder info</b>	Focus mark, defocus mark, warning mark, aperture value, shutter speed, metering mode (A, S, A/S), exposure compensation value (difference between set value and metered value) and flash ready/OK lamp with TTL Metz connection.
<b>Viewfinder Masking</b>	The image area of the Mamiya 645DF+ cameras is approximately 56 x 42 mm. A viewfinder mask is only needed for the Credo 40 model. Viewfinder masking is not necessary for Credo 80 and Credo 60 models as their light sensitive CCD measures 53.9 x 40.4 mm.
<b>AF method</b>	TTL phase difference detection method; sensor: CCD line sensor (I+I type); operating range: EV0 to EV18 (ISO 100).
<b>Focus area</b>	Displays the focus area in the viewfinder screen.
<b>AF assist beam</b>	Activates automatically under low light, low contrast.
<b>Range</b>	9 m (when using AF 80 mm f/2.8 D lens).
<b>AF lock</b>	By pressing the shutter release button halfway down in the AF-S mode, or by pressing the AFL button.
<b>Exposure modes</b>	Aperture-priority AE, shutter-priority AE, programmed AE (PH, PL setting possible), and manual.
<b>AE metering mode</b>	TTL metering, center-weighted average (Av), spot (S), and variable ratio (A-S auto).
<b>Increments of shutter</b>	Both the shutter speed and the aperture level can be set to 1/3 or speed and aperture 1/2 using the electronic dial lock function.
<b>Metering range</b>	EV 2 to EV 19 (with ISO 100 and AF80 mm f/2.8 D lens).
<b>Exposure compensation</b>	Expandable to ±5 EV.
<b>AE lock</b>	With AEL button; canceled by pressing the button again. When AEL button is pressed, exposure compensation and metering difference is displayed in the viewfinder (+-6 EV, 1/3 steps in M mode).

<b>Shutter</b>	Electronically controlled vertical metal focal plane shutter (vertical travel).
<b>Shutter speed</b>	AE 30 to 1/4000 sec (1/8 step), manual 30 to 1/4000 sec (1/2 or 1/3 steps), X, bulb (Bulb, electronically controlled), tIME, shutter curtain protection mechanism.
<b>Auto bracket shot</b>	Enable with auto bracket button (3 frame shots, 5 frame or 7 frame shot with auto bracketing). Specify 1/3, 1/2, 2/3 or 1 EV steps.
<b>Flash sync</b>	X contact point, 1/125 sec. Sync speed can be changed away from terminal.
<b>Flash control</b>	TTL direct flash control, supports Metz SCA 3002 system (SCA 3952 Adapter).
<b>Mirror up shot</b>	Select by pressing the mirror up button.
<b>LCD displays</b>	Program AE mode icon, sync mode icon, shutter speed, aperture, custom function icon, user function icon, focal plane mode icon, lens shutter mode icon, AE lock icon, auto focus lock icon, mirror up icon, focus area icon, auto bracketing icon, Self-timer icon, repeat mode icon, delay mode icon, remaining battery power icon, spot metering icon, dial lock icon, flash compensation icon, exposure compensation icon, exposure compensation, delay time.
<b>Sync terminal</b>	X contact (sync speed 1/125 sec).
<b>Cable release socket</b>	On shutter button.
<b>Remote-control terminal</b>	On side of body; electromagnetic cable release RE401 and RS402.
<b>Self-Timer</b>	Self-timer intervals can be set from 0.5 to 90 sec: 0.5 to 10 sec by the sec, 10 to 90 sec in 10 sec units, 2 to 10 minutes by the minute and 10 to 6 minutes in units of 10 minutes.
<b>Depth-of-field confirmation</b>	Preview Button on body.
<b>Custom settings</b>	20 items.
<b>Tripod socket</b>	U 1/4 in and U 3/8 included.
<b>Power requirements</b>	6 AA-size batteries (alkaline-magnesium, lithium, nickel-hydride or nickel-cadmium rechargeable batteries), rechargeable Li-Ion battery pack.
<b>External power socket</b>	An external battery case can be connected.
<b>Size &amp; weight</b>	6 X 5 X 6 in / 153 X 128 X 152 mm (W x H x H) 2.3 pounds / 1030 g (body only).

\* This information is based on a linear (horizontal/vertical) measurement.

# 11.0 Software

Capture One Pro is a professional RAW converter and image editing software. It contains all the essential tools and high-end performance in one package to enable you to capture, organize, edit, share and print images in a fast, flexible and efficient workflow.

Go to <http://help.phaseone.com/en> for further information regarding Capture One. An online Users Guide can also be found under the Help menu on Windows and Mac.

## 11.1 Importing Images

1. Go to File and select **Import Images...**  
The dialog box opens to browse files.
2. Navigate to the applicable folder, card or disk in the Locations tool.
3. Select **Capture** folder (import location) and type in the job name and Metadata (copyright, caption) if desired.
4. If you want to select a naming format for the imported files, press **Format** in the Naming tool.
5. You can select all or specific images to import.
6. Press **Import All**. You can continue working while images are imported in the background.

Inserting a memory card into a card reader automatically brings up the Import Images dialog window (default preference can be changed in Capture One Pro).

### Shooting Tethered

Capture One Pro is also used to shoot tethered from a Leaf Credo back. Find out more on page 48 or for more information, consult the online User Guide available in the Capture One Help menu or go direct to

<http://www.phaseone.com/en/Imaging-Software/Capture-One.aspx>



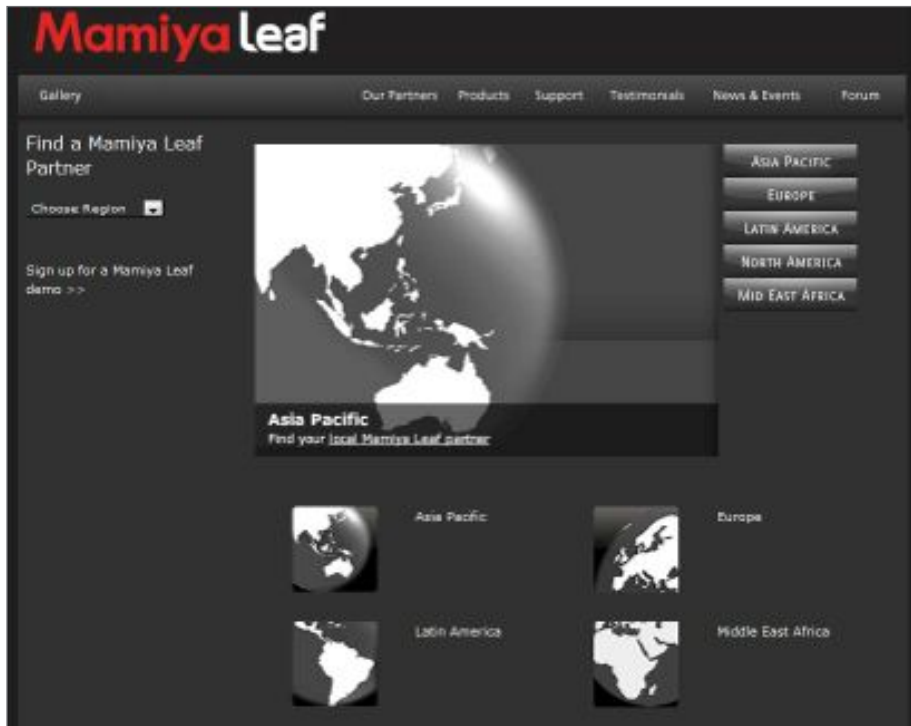

## 12.0 End User Support Policy

Mamiya Leaf guarantees world class support and service with every purchased product. Check [www.mamiyaleaf.com](http://www.mamiyaleaf.com) for the latest updated support policy.

### **Worldwide Dealer Network**

At Mamiya leaf we think globally but act locally. Mamiya Leaf's products are sold through a worldwide network of dedicated and competent local partners to make after-sales support convenient for you.

Mamiya Leaf's local partners offer first line support to their customers. Many provide additional services such as training, extended warranty agreements, upgrade programs, and many other services that add value to your Mamiya Leaf investment. Contact your local Mamiya Leaf partner to discuss your options. Digital camera back pricing and repairs are also handled locally.

If there is no local partner in your area, then contact Mamiya Leaf, and we can assist you directly or through one of our partners.

Find your local Mamiya Leaf partner or take advantage of Mamiya Leaf's wide range of online support tools at: <http://www.mamiyaleaf.com>



## 12.1 Web Resources

Mamiya Leaf offer users a host of online resources to inspire, enthuse and inform. Find detailed information including User Guides and manuals about Capture One and our digital backs at: [www.mamiyaleaf.com](http://www.mamiyaleaf.com)

### Knowledge Base

Phase One's searchable Knowledge Base at <http://support.phaseone.com> provides detailed answers to many users' questions. This 'self-service' site is free of charge and available to all Phase One owners.

### Capture One Online Support Forums

Go to Phase One's official support forum to share your experiences and get assistance from other Phase One owners as well as from Phase One's Technical Support team at <http://support.phaseone.com>

Some Phase One partners offer on-line support forums on their own websites. Please note that these forums are governed by separate rules. Phase One offers no guarantees and assumes no responsibility or liability with respect to the support provided by our local partners.

Many resources and tutorials are created on a voluntary basis, and Phase One is always interested in seeing your videos, reviews, blogs or websites concerning Phase One.

### Mamiya Leaf Official YouTube Channel

Check out our Youtube channel that provides access to tutorials, showcases, technical videos and much more at: <http://www.youtube.com/leafcamera>

### Capture-U.com - recommended by Phase One

Founded by Walter Borchenko, Capture-U provides a variety of educational texts and tests, based on RAW file workflow for Capture One Pro software users.

### Twitter

Follows us on [twitter.com/leafimaging](https://twitter.com/leafimaging) for the latest product news, promotions and much more.



# 13.0 Open Platform – Freedom of Choice

Mamiya Leaf's Open Platform policy delivers maximum choice and compatibility with a wide range of different camera platforms.

This section covers the Leaf Credo back's compatibility with the Hasselblad V and H series, Mamiya RZ67 Pro IID, Phase One 645, Mamiya 645, Contax 645 and View Camera solutions.

## **Double Exposure Protection**

It is not possible to accidentally double expose an image by capturing one shot quickly after another when a Leaf Credo back is used on cameras such as the Mamiya 645DF+/DF/AF, Phase One 645DF+/DF/AFDIII or Hasselblad 555 ELD (DIG mode). The electronic communication with the body ensures that the Leaf Credo back is ready before allowing release of the next shot. However, users of other camera bodies that do not use the electronic interface from the Credo must wait for the ready beep signal before releasing the next shot.

## **Viewfinder Masks**

Cameras including the Mamiya RZ67 Pro IID and Hasselblad V-series need a viewfinder mask as the image area of these models is different to the image sensor size of the three Credo models.

## 13.1 More Details: Leaf Credo and Mamiya 645 Series Cameras

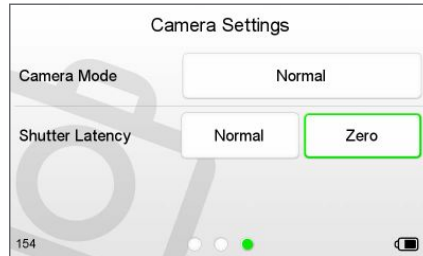
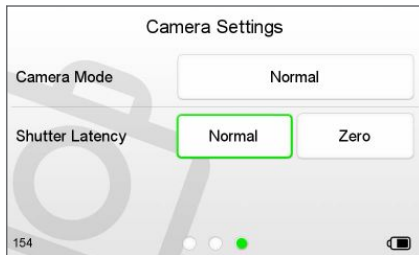

### Power Management and Shutter Latency

The Credo CCD is put to sleep to reduce power consumption when it is not in use. The Credo needs to wake up before shooting and the timing of this wake up signal is referred to as the Shutter Latency.

The Leaf Credo and Mamiya 645DF+ camera body response time is independent of the shutter latency setting so it is therefore recommended to keep the latency on the Normal (default) setting, as this ensures a longer battery life.

### Studio Flash Sync on the Camera Body

A flash sync lead should be connected to the camera body when using the Leaf Credo back on Mamiya 645DF+, DF, AF, Mamiya AFD or AFDII models.

Always use a flash cable and/or equipment that provides grounding for the flash.

### Image Orientation

The CCD in the Leaf Credo back is positioned in a landscape orientation. However, the Leaf Credo back has an internal sensor that detects when it has been rotated. Thus, when the camera is rotated and an image is captured in portrait position the image appears correctly oriented on the LCD and in the Capture One application.

Image (left) features the V-Grip Air. Mamiya Leaf Part # 020-00002A





## 14.0 Leaf Credo back for Mamiya RZ67 PRO IID

The Leaf Credo backs are compatible with the Mamiya RZ67 PRO IID with the use of an adapter plate.

The Mamiya 645DF+ version of a Leaf Credo back can be used on a Mamiya RZ67 PRO IID with a Mamiya RZ67 PRO IID adapter plate. (Mamiya Leaf # 518-04228A)

### 14.1 Mounting Leaf Credo back on the Mamiya RZ67 PRO IID

1. Place the bottom of the Leaf Credo back in the locking mechanism.
2. Press the button at the top of the back with your thumb and lever the back into place.
3. Release the button to lock into position.

**Note:** It is important to ensure that the bottom part of the Leaf Credo back is attached correctly before the upper locking mechanism is pressed together.

#### Mounting the Leaf Credo back Vertically

The CCD in the Leaf Credo back is positioned in a landscape orientation. However, it is possible to mount the Leaf Credo back in an upright orientation to capture images in a portrait format without having to rotate the camera. The Leaf Credo back has an internal sensor that detects when it has been rotated so images appear correctly oriented on the LCD and in the Capture One application.

Mount the Leaf Credo back in the portrait position by lining up the adapter mount to the corresponding indentations on the left side of the back. Press the button and lever the back into place. Release the button to lock into position.



## 14.2 Viewfinder Masking

The image area of the Mamiya RZ67 Pro IID at 56 x 69.5 mm is larger than the size of the three Credo models' sensors so it is necessary to insert a viewfinder mask.

There are two different masks available for the Mamiya RZ67 Pro IID according to the specific Credo that is being used. (The Credo 80 and Credo 60 models' CCD is 53.9 x 40.4 mm while the Credo 40's CCD measures 43.9 x 32.9 mm).

### Installing a Viewfinder Screen

4. Remove the viewfinder from the camera body according to the manufacturer's instructions.
5. Remove the focusing screen, and then replace it with the supplied focusing screen.
6. Reinstall the viewfinder on the camera body according to the manufacturer's instructions.

**Note:** Check the relevant Mamiya RZ67 Pro IID manual regarding how to dismount the viewfinder and remove the focus screen.

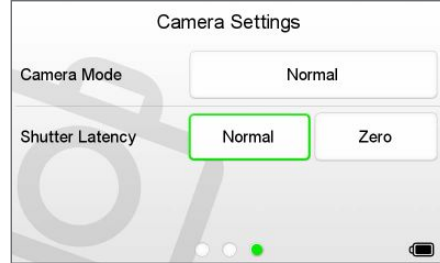

## 14.3 More Details: Mamiya RZ67 Pro IID

### Mode Selector

The mode selector on the trigger button should be turned to the white dot when used with the Leaf Credo back. The selector should be set to the orange dot to avoid draining the small battery when the Leaf Credo back is attached to the body and not in use.

**Warning:** Even if the Leaf Credo back is turned off, the battery drains slowly if the orange dot is not selected.

### Shutter Latency Setting Mamiya RZ67 PRO IID

Select the special Mamiya RZ67 PRO IID camera mode, which is available in the Camera mode menu to ensure that the correct latency setting is used.

### Studio Flash Sync on the RZ lens

A flash sync lead should be connected to the port on a lens when a Leaf Credo back is used on a Mamiya RZ67 PRO IID. On the older PRO II, use the flash sync connector on the Adapter plate. (The flash sync port on the Leaf Credo back is for use with large format cameras where no digital interface is available).

### Mirror Up

Mirror up operation is only recommended if using Mamiya's own double cable release.

### Double Exposure

It is only possible to get a double exposure when a Hasselblad V mount plate is being used. Avoid a double exposure by waiting for a ready-beep from the Leaf Credo back before capturing another image.

# 15.0 Leaf Credo back for Hasselblad V Series

The Leaf Credo back can be mounted on a wide range of Hasselblad cameras including Hasselblad 555 ELD, 553 ELX, 501 CM and 503 CW.

## 15.1 Mounting the Leaf Credo back on a Hasselblad V Series Camera

1. Place the bottom of the Leaf Credo back in the locking mechanism.
2. Press the button at the top of the back with your thumb and lever the back into place.
3. Release the button to lock into position.

**Note:** It is important to ensure that the bottom part of the Leaf Credo back is attached correctly before the upper locking mechanism is pressed together.

### Mounting the Leaf Credo back Vertically

The CCD in the Leaf Credo back is positioned in a landscape orientation. However, it is possible to mount the Leaf Credo back in an upright orientation to capture images in a portrait format without having to rotate the camera. The Leaf Credo back has an internal sensor that detects when it has been rotated so images appear correctly oriented on the LCD and in the Capture One application.

Mount the Leaf Credo back in the portrait position by lining up the adapter mount to the corresponding indentations on the left side of the back. Press the lock button (circled left) and lever the back into place. Release the button to lock into position.

### Warning! DO NOT MOUNT WHILE IN S OR RS MODE

**Note:** The Leaf Credo back should not be mounted while the camera is set to mirror up (S or RS modes). The camera should be set to AS, A or 0 mode. Also ensure that the lens is cocked when connecting the flash sync cable to the Leaf Credo back.

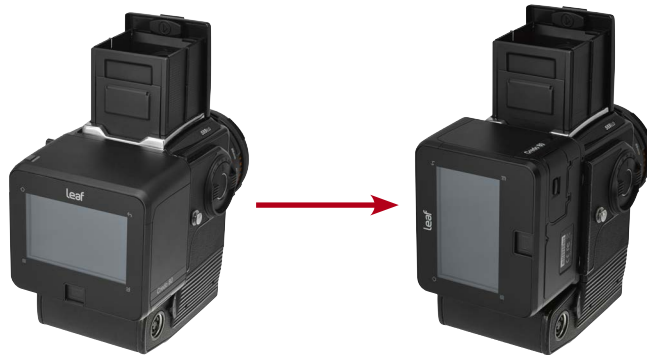





## 15.2 Mounting a Viewfinder Mask on a Hasselblad V Series Camera

The image area of a Hasselblad V camera body (approximately 6 x 6 cm) is a different size than the three Credo model's sensors so it is necessary to insert a viewfinder mask.

There are two different masks available for Hasselblad V series cameras according to which Credo is being used. The size of Credo 80 and Credo 60 models CCD is 53.9 x 40.4 mm while the Credo 40's CCD measures 43.9 x 32.9 mm.

### Insert a Viewfinder Mask

1. Dismount the waist-level finder and remove the focus screen.
2. Place the viewfinder mask in the bracket that holds the focusing screen.
3. Re-mount the viewfinder focus screen.
4. Slide the waist-level finder back into place.

**Note:** Check the relevant Hasselblad camera manual before removing the focus screen.



## 15.3 More Details: Hasselblad V Series

### Sync Cable

A sync cable is always connected from the lens to the small connector in the front plate on either the left or right side of the Leaf Credo back regardless of which Hasselblad V type camera used.

### Flash Lead Connection

A flash cable is always connected to the F-connector on the Leaf Credo back with all Hasselblad V series cameras.

### Mirror Up and Shutter Latency Setting

Set the Latency to Zero when shooting with a Hasselblad 903 CW and 905 CW.

### Tethered Capture

Plug a FireWire 800 cable into the Leaf Credo back for tethered capture to a computer using Capture One Pro.

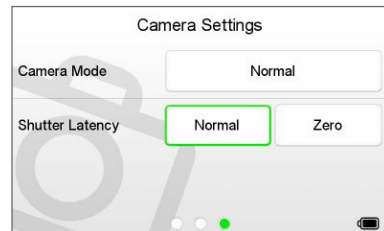





## 15.4 Hasselblad 555 ELD

Ensure that the shutter release on the front of the Hasselblad 555 ELD is in the **DIG** position when using a Leaf Credo back.

If for any reason you have to use the 555 ELD in Film position (e.g. if the DIG is not working), then set the **Shutter Latency** on the Credo to Zero.

### Shutter Latency Setting

The Leaf Credo back can be used with both Normal and Zero latency with the Hasselblad 555 ELD.

A Leaf Credo back has a default Normal latency setting that helps to save battery life. But users may experience unwanted double exposures when using a 2-shot release cable.

### Motor Cable on Hasselblad 555 ELD

A motor cable is not required when using a Leaf Credo back on a Hasselblad 555 ELD body.

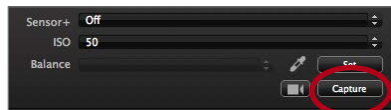

## 15.5 Hasselblad 553 ELX

When using the Leaf Credo back on some Hasselblad motorized bodies (e.g. Hasselblad ELX or Hasselblad ELM series), a motor cable is supplied to enable users to fire the camera shutter from a computer using the Capture One Pro Capture button. (See circled button left).

### Cable Connections

The cable is connected between the multi-connector on the Leaf Credo back and the DIN connector on the Hasselblad. Ensure that **A** or **AS** modes are not used.

**WARNING!** Please note that the Leaf Credo back should not be mounted while the camera is set to **Mirror Up (S or RS modes)**. Make sure that the lens is not jammed or locked open on the **B** setting when connecting the flash sync cable to the Leaf Credo back.

### Shutter Latency Setting

Set the latency setting to Normal on the Leaf Credo back while using a Hasselblad 553 ELX.

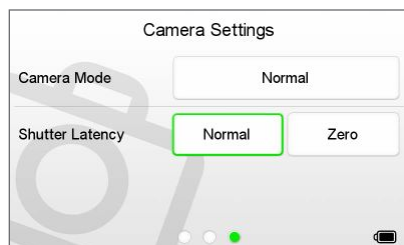

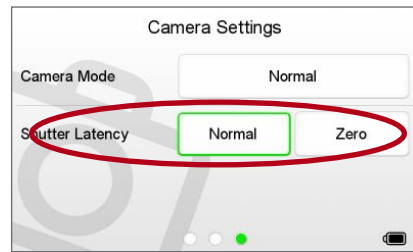
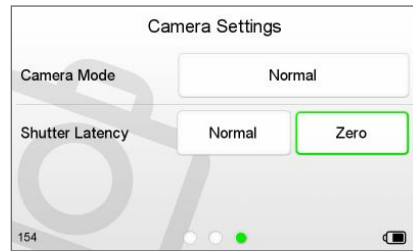

## 15.6 Hasselblad 501 CM and 503 CW without Winder

The Leaf Credo back can also be used with mechanical Hasselblad cameras such as the 501 CM and 503 CW. These cameras are operated in single shot mode via the shutter release button or a standard cable release.

**WARNING!** Please note that the Leaf Credo back should not be mounted when the camera is set to **Mirror Up**. Also ensure that the lens is not jammed or locked open on the **B** setting when connecting the flash sync cable to the Leaf Credo back.

### Shutter Latency Setting

While using a mechanical Hasselblad, set the latency setting to **Normal** on the Leaf Credo. When using the Mirror Up function or if you need to rapidly press the shutter button, set the latency setting to **Zero**. Precautions must be taken not to trigger the shutter too fast when using Normal latency.

## 15.7 Hasselblad 503 CW with Winder CW

**WARNING!** Please note that the Leaf Credo back should not be mounted when the camera is set to Mirror Up. Make sure that the lens is not jammed or locked open on the **B** setting when connecting the flash sync cable to the Leaf Credo back.

Set the Shutter Latency to **Zero** when using a 503 CW winder with a Leaf Credo back.



## 15.8 Cables shipped with Leaf Credo back for Hasselblad V

Classic and Value Added backs come with all the cables needed for the specific camera platform. A Value Added back also comes with an additional 50300143 cable for use with large format and technical cameras.

**Part# 50300145** Motor cable for Hasselblad ELX (for host capture when the Leaf Credo back is used on a Hasselblad ELX body).

**Part# 50300148** Sync cable short (for use with all Hasselblad medium format bodies).

**Part# 50300143** Multi connector to Lens sync (for use with large format in 2-shot mode).

**Part# 50300144** This cable is available as a separate purchase only.

From multi connector to mini jack female (to adapt older large format wake-up cables or older Kapture Group one shot adapter cables to connect to the multiport).



## 16.0 Leaf Credo Back for Hasselblad H Series

The Leaf Credo (H-mount) digital back is designed specifically for Hasselblad H1 and H2 cameras.

### 16.1 Mounting the Leaf Credo back on the Hasselblad H1/H2

1. Place the bottom of the Leaf Credo back in the locking mechanism.
2. Lever the back into place.
3. Do not let go of the back until you hear a clicking noise that signals the back is locked into position.

**Note:** It is important to ensure that the bottom part of the Leaf Credo back is attached correctly before the upper locking mechanism is pressed together.

### Removing the Leaf Credo back from the Hasselblad H1/H2

1. Rotate and press the silver button (illustrated left) to unlock the back. (Ensure that the back is supported in your hand before pressing this button).
2. Gently lever away the top of the back first. Be careful with the contacts and protective glass on the back.

**Note:** Your Leaf Credo back should always be protected by its plate when it is not attached to the camera.



## 16.2 Viewfinder Masking

The image area of the Hasselblad H1/H2 cameras is 56 x 41.5 mm. A viewfinder mask is only needed for the smaller size of the Credo 40 CCD that measures 44 x 33 mm. Viewfinder masking is not necessary for Credo 80 and Credo 60 models as their light sensitive CCD measures 53.9 x 40.4 mm.

Insert a Viewfinder Mask

1. Dismount the prism/waist-level finder.
2. Place the viewfinder mask on the focusing screen.
3. Re-mount the viewfinder focus screen.

**Note:** Check the relevant Hasselblad H-series manual regarding how to dismount the prism/waist-level finder.



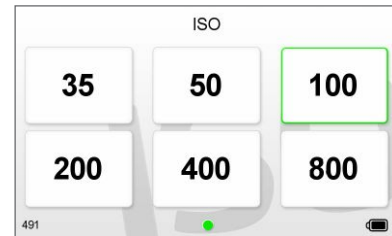
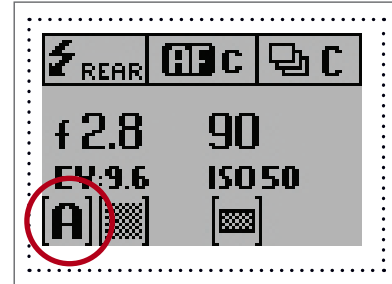

## 16.3 More Details: Hasselblad H Series

### Camera Display

The Hasselblad H1/H2 incorporates a screen that displays information about the camera set-up. It shows the aperture value, AF mode, shutter speed etc.

The Hasselblad H1/H2 also displays some Leaf Credo back information on this screen. For example, error messages including **Digital back storage media is full** are displayed on the screen if the CompactFlash card being used by the Credo back is full to capacity.

### ISO Settings

The ISO value is also displayed on the H1/H2 camera screen. The ISO setting can be adjusted from the camera back or in Capture One software when shooting tethered.

Consult page 24 of this manual for details on setting the ISO. Go to page 49 for more information about tethered shooting.

### Auto Exposure

All the Hasselblad H1/H2 auto exposure modes are fully supported by the Leaf Credo back.

Check the relevant Hasselblad H-series manual for more information on exposure modes.

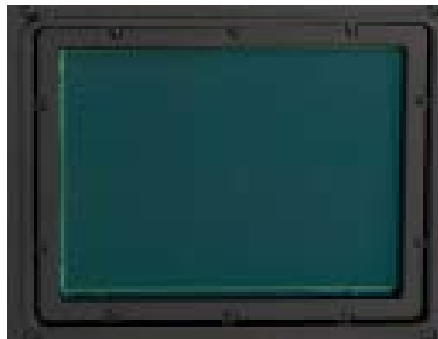

## Viewfinder Information

The viewfinder information bar is located below the image area within the viewfinder display. It displays the camera's exposure mode and values etc. It also includes a counter with the number of captures remaining on the storage media (see top bar circled left). '99' is the maximum number displayed. '99' continues to be displayed if there are more than that remaining on a CompactFlash card. An 'E' indicates that the storage media is full. Users must delete some captures or replace the CompactFlash card before continuing (see bottom bar circled left).

## Double Exposure Protection

It is not possible to accidentally double expose an image by capturing one image quickly after another when a Leaf Credo back is used on a Hasselblad H1/H2.

**Note:** At the end of an exposure, image information has to be moved from the CCD to the processing system. During this short period of time the CCD must be protected from light exposure. The Leaf Credo back ensures that the CCD is safely cleared of information by disabling the Hasselblad camera's shutter release during this procedure.

## Image Orientation

The CCD in the Leaf Credo back is positioned in a landscape orientation. However, the Leaf Credo back has an internal sensor that detects when it has been rotated. Thus, when the camera is rotated and an image is captured in portrait position the image appears correctly oriented on the LCD and in the Capture One application.



### Flash Lead Connection

A flash cable is always connected to the Hasselblad H1/H2 camera body.

The flash sync cable must not be connected to the camera back when used on a Hasselblad H1/H2. The flash sync connector on the Leaf Credo back is only intended for use with a large format adapter.

### 16.4 Cables Shipped with Leaf Credo back for Hasselblad H

No cables are required to use the Leaf Credo back with a Hasselblad H1/H2.

A Gold package Leaf Credo back comes with an additional multi-connector to Lens sync cable (part# 50300143) for use with large format cameras in 2-shot mode.

**Part# 50300144** This cable is available as a separate purchase only.

From multi-connector to mini jack female (to adapt older large format wake-up cables or older Kapture Group 1-shot adapter cables to connect to the multiport).

# 17.0 Leaf Credo back for Contax 645

The Leaf Credo (Contax mount) digital back is designed specifically for the Contax 645 camera. The Leaf Credo back communicates with the Contax 645 through a fast internal electrical computer interface and utilizes TTL phase difference detection type auto focus system.

## 17.1 Mounting Leaf Credo back on a Contax 645

1. Place the bottom of the Leaf Credo back in the locking mechanism.
2. Press the button at the top of the back with your thumb and lever the back into place.
3. Release the button to secure it into position.
4. Lock the Leaf Credo back into place by sliding the switch left towards the release button.

**Note:** It is important to ensure that the bottom part of the Leaf Credo back is attached correctly before the upper locking mechanism is pressed together.

## Removing the Leaf Credo back from the Contax 645

1. Slide the locking switch to the right position.
2. Press the button to unlock the back. Ensure that the back is supported in your hand before pressing this button.
3. Gently lever away the top of the back first. Be careful with the contacts and protective glass on the back.

**Note:** Your Leaf Credo back should always be protected by its plate when it is not attached to the camera.



## 17.2 Viewfinder Masking

The image area of the Contax 645 camera is 56 x 41.5 mm. A focusing screen is only needed for the smaller size of the Credo 40 CCD that measures 44 x 33 mm. Changing viewfinders is not necessary for Credo 80 and Credo 60 models as their light sensitive CCD measures 53.9 x 40.4 mm.

### Installing the Focusing Screen

To remove the original focusing screen:

1. Remove the Contax viewfinder.
2. Pick up the screen frame claw with your finger tip, and pull it gently upwards to remove the focusing screen.

To install the supplied focusing screen:

1. Insert the edge of the focusing screen underneath the screen pressing spring.
2. Press the focusing screen down gently, until it locks into place with a click.

Important! Do not press or bend the screen pressing spring directly, it may damage the camera.

Never touch the surface of the focusing screen. If there is dust on the screen, use a blower or soft lens brush to remove it.

Store unused focusing screens in the screen case according to the instructions on the case.

**Note:** Check the relevant Contax 645 manual regarding how to dismount the viewfinder and remove the focus screen.

## 17.3 More Details: Contax 645

### Exposure Modes

The Contax 645 manual (M) and semi-auto exposure modes (Av, Tv) are fully supported by the Leaf Credo back. Please note that Bulb is only supported on Contax/Leaf Credo back when used in conjunction with the Live View function. Go to Chapter 19 (from page 142) for more information about Live View.

Check the relevant Contax 645 manual for more information on exposure modes.

Ensure that exposure times are limited between 1/4000 second and approximately one second to obtain the highest possible quality with a Leaf Credo back and Contax 645. Please note that it is not possible to expose images longer than two minutes with a Leaf Credo 80 and 60 seconds with a Leaf Credo 60 or 40.

### ISO Settings

The Contax 645 exposure modes use the ISO value set in the Leaf Credo back. The ISO setting can be adjusted from the camera back or in Capture One software when shooting tethered.

Consult page 24 of this manual for details on setting the ISO. Go to page 49 for more information about tethered shooting.

### Double Exposure Protection

It is not possible to accidentally double expose an image by capturing one image quickly after another when a Leaf Credo back is used on a Contax 645 e.g. when using the continuous drive mode.

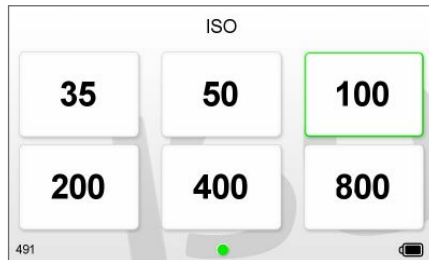



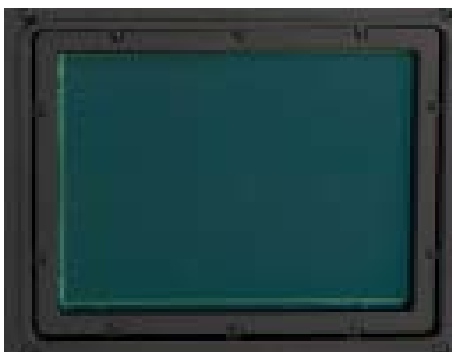

### **TTL flash**

Using TTL flash with the Contax 645 camera and Leaf Credo back results in a two f-stop overexposure. When using TTL flash, the exposure compensation on the flash unit must be set to  $-2$  f-stops.

This overexposure happens because the CCD element reflects light differently than film and this cannot be communicated to the Contax.

### **Image Orientation**

The CCD in the Leaf Credo back is positioned in a landscape orientation. However, the Leaf Credo back has an internal sensor that detects when it has been rotated. Thus, when the camera is rotated and an image is captured in portrait position the image appears correctly oriented on the LCD and in the Capture One application.

### **17.4 Flash Lead Connection**

A flash cable is always connected to the Contax 645 camera body.

The flash sync cable must not be connected to the camera back when used on a Contax 645. The flash sync connector on the Leaf Credo back is only intended for use with large format adapters.



## 17.5 Cables Shipped with Leaf Credo back for the Contax 645 (Gold package only)

**Part# 50300143** Multi-connector to Lens sync (for use with large format in 2-shot mode)

**Part# 50300144** This cable is available as a separate purchase only. From multi-connector to mini jack female (to adapt older large format wake-up cables or older Kapture Group 1-shot adapter cables to connect to the multiport).

**Part# 50300154** From multi-connector to mini jack on the Contax handgrip (used to enable host Capture from computer)

**Note:** Operating the camera from the host computer

The supplied release cable must be connected between the multiple-pin connector on the Leaf Credo back and the mini-jack connector placed at the bottom of the handgrip on the Contax camera housing.



## 18.0 Leaf Credo Back on View Cameras

The Leaf Credo back is compatible with most technical view cameras and large format cameras via camera interface adapters. The Leaf Credo back supports most mechanical shutters and some electronic shutters from Horseman, Schneider and other manufacturers.

### **Sleeping Architecture**

The Sleeping Architecture was developed to help produce noise free exposures without the use of active cooling of the CCD. The sleeping architecture ensures minimum heat build up inside the back by putting all the unused circuits to sleep, and only powering the circuits that are actually needed at any given time.



### 18.1 Using the 2-shot Release

The Leaf Credo back can be used with mechanical shutters that can be fired twice within four seconds. The first release of the shutter activates the digital back; the second release is for the exposure. If the time limit of four seconds is exceeded, the camera gives a warning 'beep' followed by a **2-shot error** warning that is displayed on the LCD screen.

There are several automatic or semi-automatic 2-shot solutions available from third party manufacturers for use with a mechanical shutter. Please ask your dealer for more information.



### 18.2 Using the 1-shot Release

The 1-shot release cable is created to simplify your studio workflow.

1. Connect the flash exit (circled left) to the shutter and plug the opposite end to the multi-pin port on the Leaf Credo back (via Part# 50300144 from multi-connector to mini jack female).
2. Connect a flash sync lead to the port on the Leaf Credo back.
3. Close the shutter if necessary.
4. Push the button (circled left) on the 1-shot release lead to 'wake up' the camera back and take the shot within a few seconds.



**Note:** It is not possible to control the exposure or trigger the shutter from Capture One when using a fully manual camera. Only limited EXIF data is recorded when shooting with manual cameras. The Leaf Credo back adds a calculated approximate shutter speed but the aperture value is not recorded.

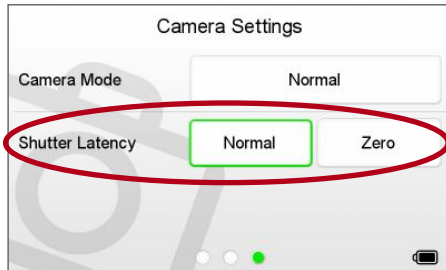
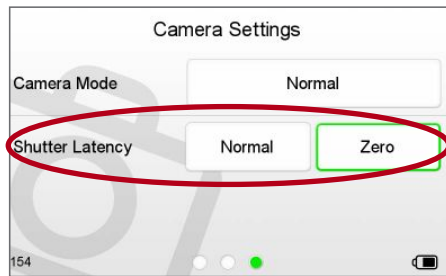

### 18.3 Shutter Latency Settings for Technical Camera Adapters

Technical camera adapters for the Leaf Credo back can be used with both normal and zero shutter latency.

Select the **Normal** latency setting if the Leaf Credo back is used on a camera with a 2-shot release.

Please note: The Zero shutter latency setting increases the power consumption of the Leaf Credo back, as it is always prepared for exposure.



## 19.0 Live View

The Live View function is intended for use when a camera is mounted on a tripod and the subject is stationary.

Live View is ideal for use with technical view cameras in a studio environment or for architectural photography, where you would ordinarily have to rely on an external viewfinder or a separate focusing glass/sliding adapter.

The Live View function enables you to compose an image directly on the high resolution display of the Credo digital back. Focus can be checked by zooming into a subject on the screen by up to 400%.



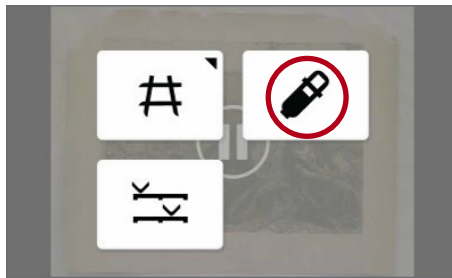
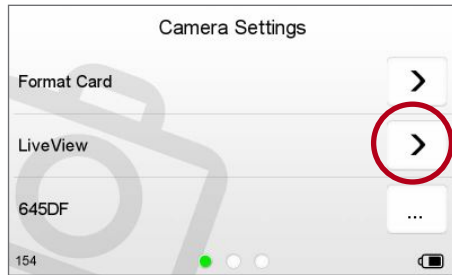

## 19.1 Starting Live View

1. Live View is accessed from the Camera Settings menu (circled left). The Camera Settings menu is always visible on the Home screen. Tap the **Home** soft button in the upper left corner of the back to reveal the Home screen if it is hidden.
2. Select **Live View** from the menu (circled left).
3. When Live View is activated, ensure that a Live View white balance is applied. Tap the **Dynamic** soft button in the lower right corner of the back to bring up the Dynamic menu and select the **White Balance Picker** (circled left).

Go to page 144 for more information about Live View white balance.

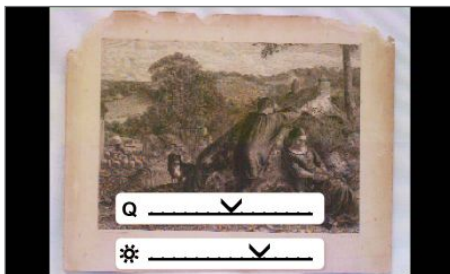
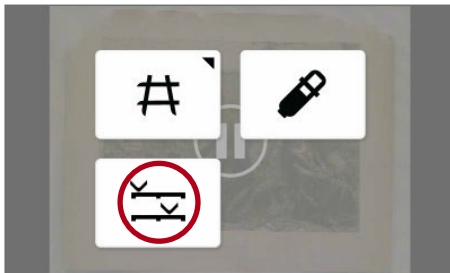
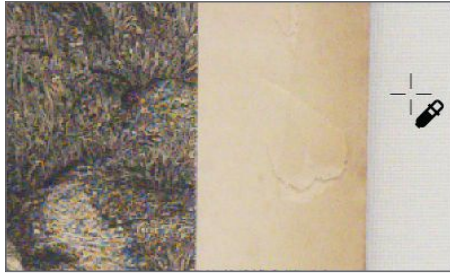

## 19.2 White Balance

1. After selecting the White Balance Picker, tap the screen to select a neutral area to calibrate the Live View.
2. If a precise white point is difficult to achieve in full screen view, slide a finger on the right side of the screen to zoom into a part of the image that you want to use as white reference.  
Exit the White Balance mode by deselecting the picker in the Dynamic menu. Alternatively, the Home soft button on the Leaf Credo back to return to the Home screen.

Go to page 62 to find out more about the zoom function.

## 19.3 Quality and Brightness

1. Go to the **Dynamic** menu and select the **Live View** exposure controls icon (circled left).
2. Two sliders appear at the bottom of the screen in order to help you adjust Live View to suit the ambient lighting conditions being used. The top slider is a speed vs. quality slider. Increase the quality by moving slide to the right or achieve a faster frame rate by moving the slider to the left. The lower slider controls the brightness of the Live View.

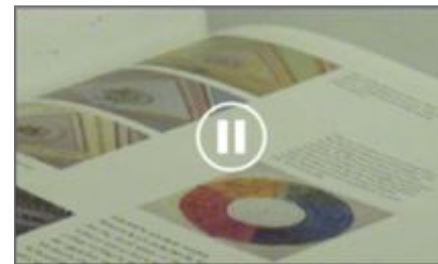
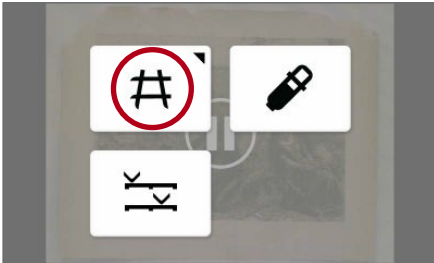
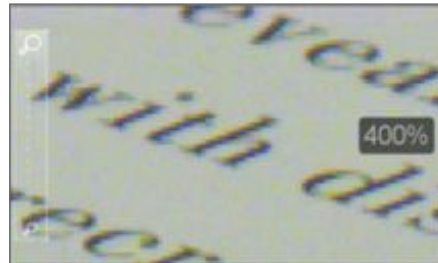

## 19.4 Zoom

Zoom into the Live View by sliding a finger up in the left side of the screen. Double tap on the image to bring up a 100% view. If a zoom is already applied, double tap the screen to return to a full image view.

## 19.5 Grid

1. Go to the **Dynamic** menu and select the **Grid** icon (circled left) to apply a default grid. Press and hold the **Grid** icon to select one of a selection of other grid options to apply to the live view.

## 19.6 Auto Stop and Start

Live View is paused if the screen is not touched for one minute. Touch the screen again to restart Live View.



## 19.7 Accessories

Live View is easily overexposed with the Credo 40, 60 and 80 due to the high sensitivity of the CCD sensor and its large size. It is sometimes necessary to take steps to prevent overexposure by either stopping down the aperture or by using a neutral density filter (ND filter). ND filters are widely available, and it is even possible to get variable ND filters, that can prove invaluable when working in changeable outdoor ambient light.

### **Recommended Suppliers**

Schneider Optics: [www.schneideroptics.com](http://www.schneideroptics.com)

Lee Filters: [www.leefilters.com](http://www.leefilters.com)

Sing Ray Vari ND: [www.singh-ray.com](http://www.singh-ray.com)

The Credo 50 employs a CMOS sensor which offers improved performance of the Live View function in most lighting conditions and does not require the use of ND filters.

## 19.8 Live View Camera Support

The Leaf Credo back Live View function is supported on both medium and large format view cameras. Find out how to operate Live View from the following list of cameras:

### **View Cameras**

1. Open the lens and select the desired aperture value.
2. Activate **Live View** on the Leaf Credo back.

### **Mamiya 645DF+/645AF/645DF**

1. Activate **Live View** on the Leaf Credo back.
2. Adjust the exposure time dial until the camera display states **tIME**.
3. Press the camera shutter button.

### **Hasselblad H1/H2**

1. Activate **Live View** on the Leaf Credo back.
2. Select the **M** (Manual) mode.
3. Select the desired aperture value.
4. Set the shutter to **T mode**.

Note: It is only possible to change the aperture when the camera body is idle/not exposing. Exit the T-mode to change aperture.

### **Hasselblad V**

1. Activate Live View on the Leaf Credo back.
2. Select **B** (Bulb) mode.

### **Mamiya RZ67 Pro IID**

1. Activate Live View on the Leaf Credo back.
2. Select **B** (Bulb) mode.

**Note:** It is only possible to change the aperture when the camera body is idle/not exposing. Exit the **Bulb** mode to change aperture.

### **Contax 645**

1. Activate Live View on the Leaf Credo back.
2. Select **B** (Bulb) mode.
3. Select the desired aperture value.

**Note:** It is only possible to change the aperture when the camera body is idle/not exposing. Exit the **Bulb** mode to change aperture.



# 20.0 Appendix

## Firmware Credits

### Libjpeg

This software is based in part on the work of the Independent JPEG Group.

### zlib

Interface of the 'zlib' general purpose compression library

Copyright (C) 1995-2012 Jean-loup Gailly and Mark Adler

This software is provided 'as-is', without any express or implied warranty. In no event will the authors be held liable for any damages arising from the use of this software.

Permission is granted to anyone to use this software for any purpose, including commercial applications, and to alter it and redistribute it freely, subject to the following restrictions:

1. The origin of this software must not be misrepresented; you must not claim that you wrote the original software. If you use this software in a product, an acknowledgment in the product documentation would be appreciated but is not required.
2. Altered source versions must be plainly marked as such, and must not be misrepresented as being the original software.
3. This notice may not be removed or altered from any source distribution.

Jean-loup Gailly

jloup@gzip.org

Mark Adler

madler@alumni.caltech.edu



**Mamiya** leaf

<http://www.mamiyaleaf.com>